

Tubular Flooded SOPzS Block

Discover[®] Tubular Flooded SOPzS batteries provide superior deep cycling performance and reliability for demanding commercial, industrial and residential applications. Providing reliable energy storage for Stationary Backup and Telecom Networks, and Renewable Energy applications with its Advanced Tubular Plate Technology to deliver long service life with low maintenance requirements. Discover[®] Tubular Flooded OPzS batteries provide maximum efficiency per discharge-charge cycle, and proven reliability in remote, high temperature, or unstable power network installations.

MECHANICAL DRAWINGS

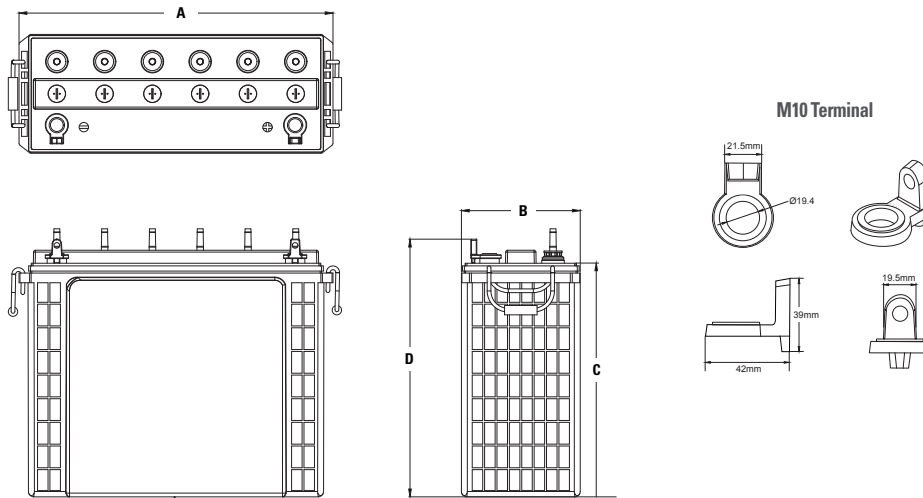

MECHANICAL SPECIFICATIONS

| Industry Reference | Tubular Flooded SOPzS | |
|--------------------|-----------------------|----------|
| Length (A) | 19.9 in | 505 mm |
| Width (B) | 7.48 in | 190 mm |
| Height (C) | 14.7 in | 374 mm |
| Total Height (D)* | 16.1 in | 410 mm |
| Weight (Wet) | 134 lbs | 60.8 kgs |
| Weight (Dry) | - | - |
| Terminal | M10 | |
| Poles | 2 | |
| Cell(s) | 6 | |
| Container | PP | |

ELECTRICAL SPECIFICATIONS

| | | |
|-------------------------------|------------------------------|-------------|
| Voltage | 12 | |
| Reference LVD / I10 | 20% DOD | 12.3 V |
| | 50% DOD | 12.0 V |
| | 80% DOD | 11.6 V |
| Cycle Life | 20% DOD | 4500 cycles |
| | 50% DOD | 2000 cycles |
| | 80% DOD | 1100 cycles |
| Internal Resistance | 5mΩ +/-1.5 | |
| Short Circuit | 2150 A | |
| Self Discharge | 5% per month | |
| Maximum Operating Temperature | -35°C / -31°F 50°C / 122°F | |
| Electrolyte | 1.255 S.G. | |

ELECTRICAL SPECIFICATIONS

| 240 HR | 120 HR | 100 HR | 20 HR | 10 HR | 5 HR | 3 HR | 1 HR |
|---------------------------|--------|--------|---------------------------|--------|--------|--------|--------|
| 1.85 Volts Per Cell (VPC) | | | 1.75 Volts Per Cell (VPC) | | | | |
| 255 AH | 245 AH | 238 AH | 210 AH | 185 AH | 160 AH | 139 AH | 119 AH |

NOTE: All Electrical Specifications are based on 20°C / 68°F temperature.

BENEFITS & FEATURES

Long Service Life

Tubular positive plates with polyester gauntlets are designed to prevent active material plate shedding and provide the highest cycling expectancy amongst lead acid technologies, particularly in PSoC (Partial State of Charge) operation.

High energy density tubular plates in combination with lead calcium alloy reduces self discharge and charge current requirements during float operation and extends battery service life.

Performance and Reliability

Battery containers are made of Polypropylene (PP) to endure high impact and heat environments.

Maintenance and Optimization

SOPzS Flooded batteries are manufactured with reduced watering frequency requirements and translucent containers with water level indicators to easily monitor electrolyte level.

Safety

All products are tested and certified to multiple international safety standards for use in Photovoltaic and Stationary applications. Centralized gassing and watering kits are available upon request.

Lowest Total Cost of Ownership

SOPzS Tubular batteries provide the Lowest Total Cost of Ownership (TCO) amongst lead acid technologies. Further savings can be achieved in Hybrid systems through diesel abatement and peak shaving.

CERTIFIED QUALITY

Discover and its manufacturing facilities are fully certified to ISO 9001/14001 and OSHA 18001 standards. OPzS and OPzV Tubular products are also tested in compliance to multiple international standards:

- Eurobat "Long Life" classification
- IEC 60896-21/22 (OPzV) and IEC60896-11 (OPzS) test standard for stationary applications
- IEC 61427 test standard for photovoltaic energy systems
- EN50272-1 and EN50272-2 safety requirements
- DIN 40742 (OPzV) and DIN 40736 (OPzS) standard for stationary tubular plate cells
- UN 2800 (US DOT Compliance)



EXPECTED NUMBER OF CYCLES IN RELATION TO THE DEPTH OF DISCHARGE

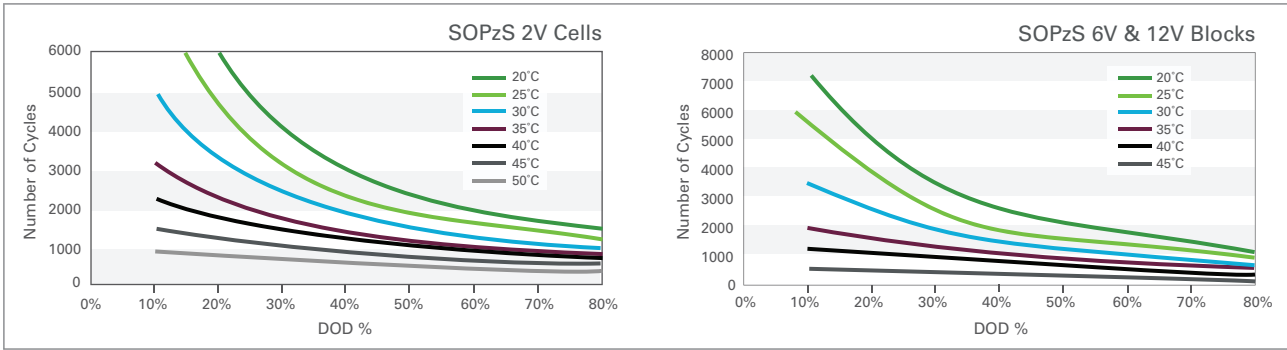

SELF-DISCHARGE CHARACTERISTICS

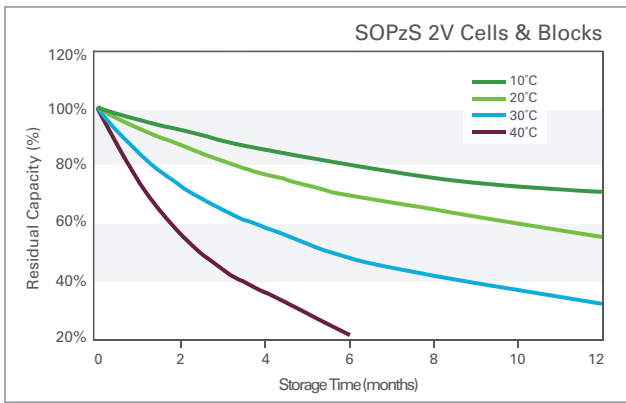

CAPACITY VS. TEMPERATURE

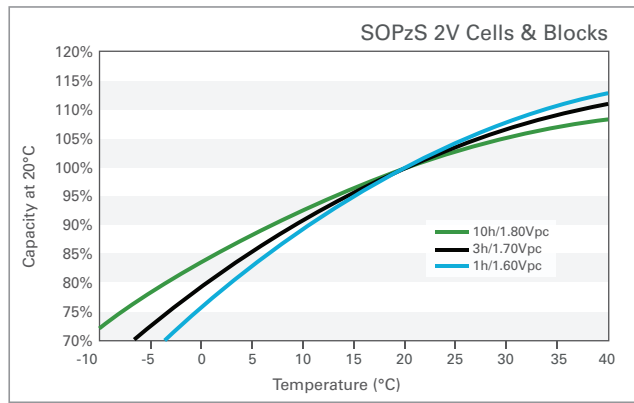

CHARGE SETTINGS FOR CYCLIC USE (25°C)

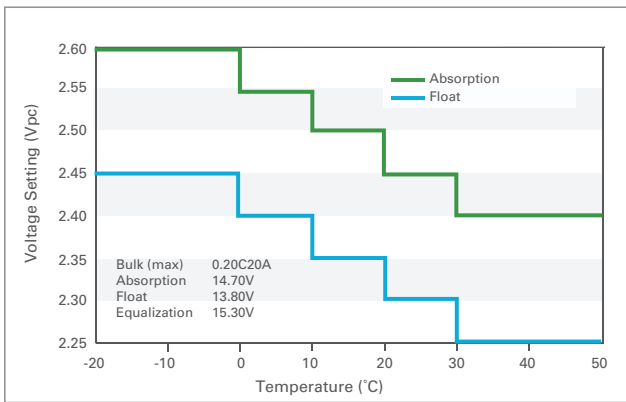

CHARGE SETTINGS FOR STANDBY USE (25°C)

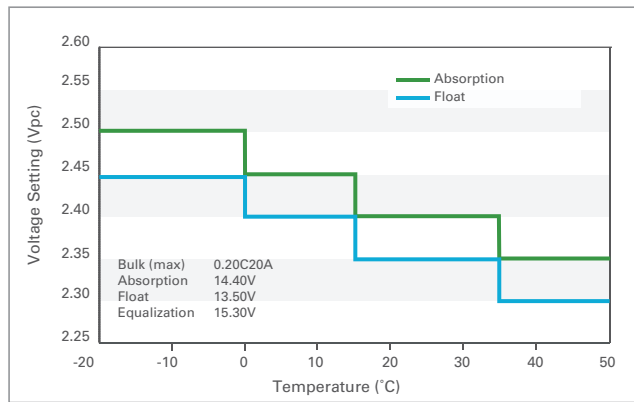

Discover® attempts to ensure the correctness of the product description and data contained herein. We reserve the right to change designs, specifications and pricing at any time without notice or obligation. It is the responsibility of the reader of this information to verify any and all information presented herein.