

Tubular Flooded OPzS Cell

Discover[®] Tubular Flooded OPzS batteries provide superior deep cycling performance and reliability for demanding commercial, industrial and residential applications. Providing reliable energy storage for Stationary Backup and Telecom Networks, and Renewable Energy applications with its Advanced Tubular Plate Technology to deliver long service life with low maintenance requirements. Discover[®] Tubular Flooded OPzS batteries provide maximum efficiency per discharge-charge cycle, and proven reliability in remote, high temperature, or unstable power network installations.

MECHANICAL DRAWINGS

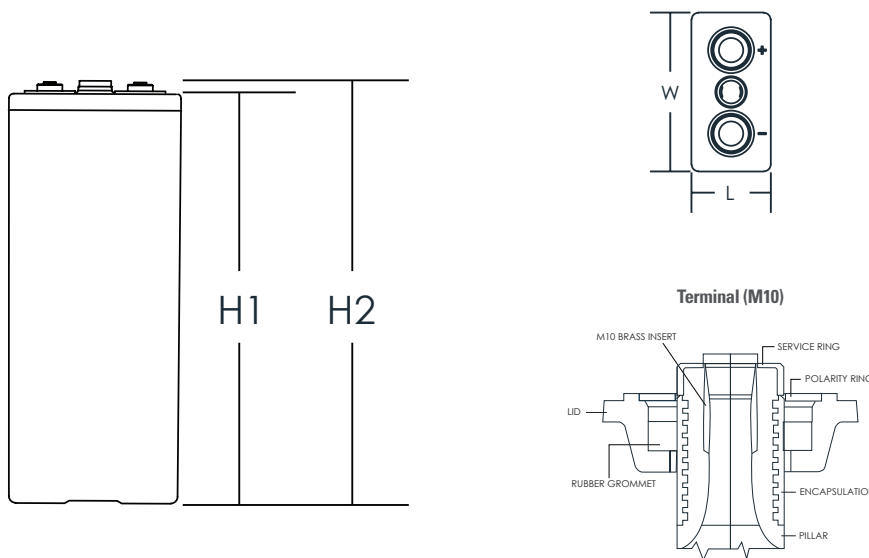

MECHANICAL SPECIFICATIONS

Industry Reference	Tubular Flooded OPzS	
Length (A)	6.6 in	168 mm
Width (B)	8.2 in	208 mm
Height (C)	19.1 in	484 mm
Total Height (D)	20.0 in	509 mm
Weight (Wet)	82 lbs	37 kgs
Weight (Dry)	60 lbs	27 kgs
Terminal	M10	
Poles	2	
Cell(s)	1	
Container	SAN	

ELECTRICAL SPECIFICATIONS

Voltage	2	
Reference LVD / I10	20% DOD	2.05V
	50% DOD	1.97V
	80% DOD	1.91V
Cycle Life	20% DOD	7000 cycles
	50% DOD	2950 cycles
	80% DOD	1900 cycles
Internal Resistance	0.50 mΩ	
Short Circuit	4050 A	
Self Discharge	2-3% per month	
Maximum Operating Temperature	-35°C / -31°F 50°C / 122°F	
Electrolyte	1.24 S.G.	

ELECTRICAL SPECIFICATIONS

240 HR	120 HR	100 HR	20 HR	10 HR	5 HR	3 HR	1 HR
1.85 Volts Per Cell (VPC)			1.75 Volts Per Cell (VPC)				
780 AH	750 AH	735 AH	595 AH	541 AH	475 AH	408 AH	260 AH

NOTE: All Electrical Specifications are based on 20°C / 68°F temperature.

BENEFITS & FEATURES

Long Service Life

Tubular positive plates with non-woven polyester gauntlets are designed to prevent active material plate shedding and provide the highest cycling expectancy amongst lead acid technologies, particularly in PSoC (Partial State of Charge) operation.

High energy density tubular plates in combination with lead calcium alloy reduces self discharge and charge current requirements during float operation and extends battery service life.

Performance and Reliability

Special sliding pole terminals are designed to accommodate natural grid growth occurrence throughout battery lifetime. Battery containers are made of Styrene Acrylonitrile (SAN) to endure high impact and heat environments.

Maintenance and Optimization

OPzS Flooded batteries are manufactured with reduced watering frequency requirements and transparent containers to easily monitor electrolyte level.

Safety

All products are tested and certified to multiple international safety standards for use in Photovoltaic and Stationary applications. Flame retardant containers and centralized gassing and watering kits are available upon request.

Lowest Total Cost of Ownership

OPzS Tubular batteries provide the Lowest Total Cost of Ownership (TCO) amongst lead acid technologies. Further savings can be achieved in Hybrid systems through diesel abatement and peak shaving.

CERTIFIED QUALITY

Discover and its manufacturing facilities are fully certified to ISO 9001/14001 and OSHA 18001 standards. OPzS and OPzV Tubular products are also tested in compliance to multiple international standards:

- Eurobat "Long Life" classification
- IEC 60896-21/22 (OPzV) and IEC60896-11 (OPzS) test standard for stationary applications
- IEC 61427 test standard for photovoltaic energy systems
- EN50272-1 and EN50272-2 safety requirements
- DIN 40742 (OPzV) and DIN 40736 (OPzS) standard for stationary tubular plate cells
- UN 2800 (US DOT Compliance)



EXPECTED NUMBER OF CYCLES IN RELATION TO THE DEPTH OF DISCHARGE

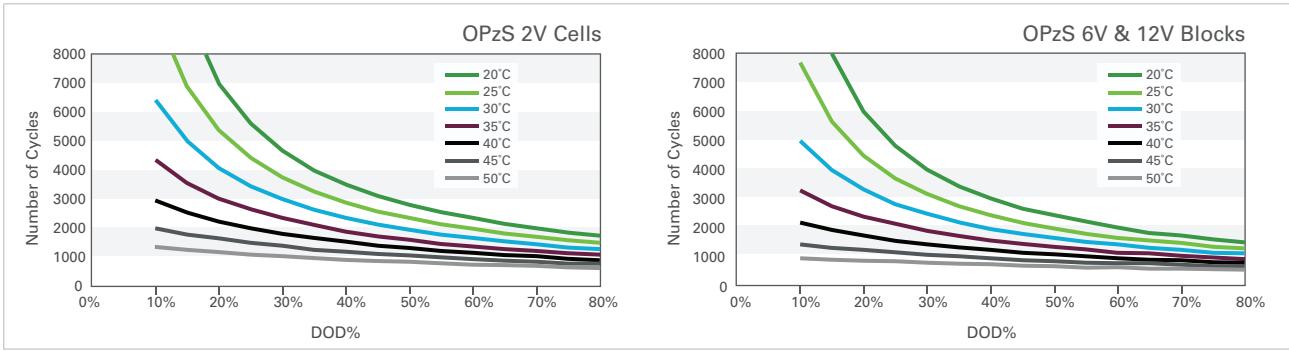

CAPACITY IN RELATION TO THE TEMPERATURE

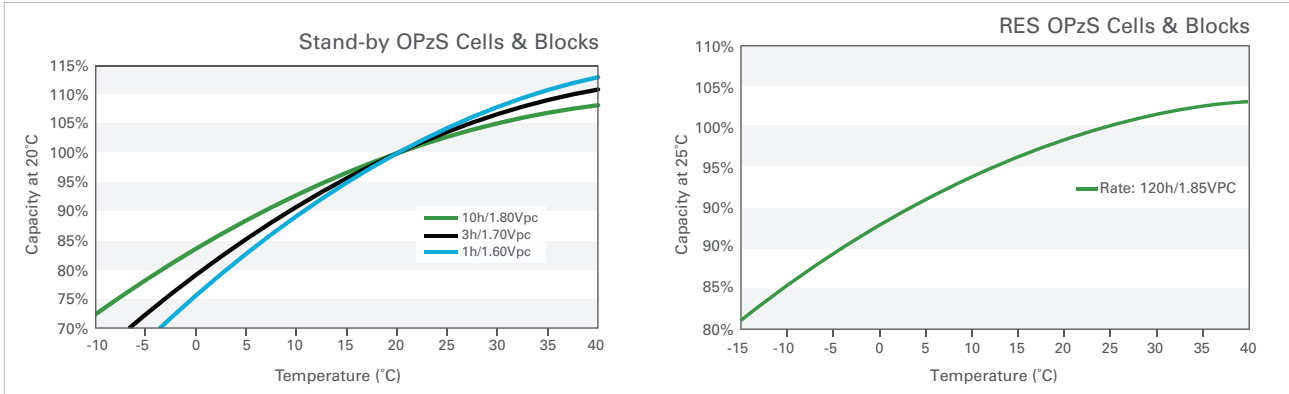

SELF-DISCHARGE CHARACTERISTICS

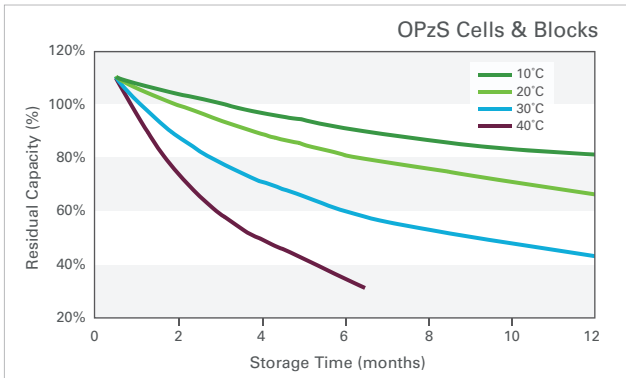

EXPECTED SERVICE LIFE IN RELATION TO OPERATING TEMPERATURE

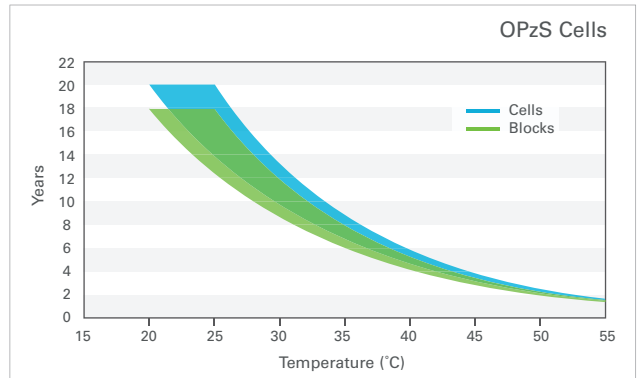

FLOAT VOLTAGE SETTING IN RELATION TO OPERATING TEMPERATURE

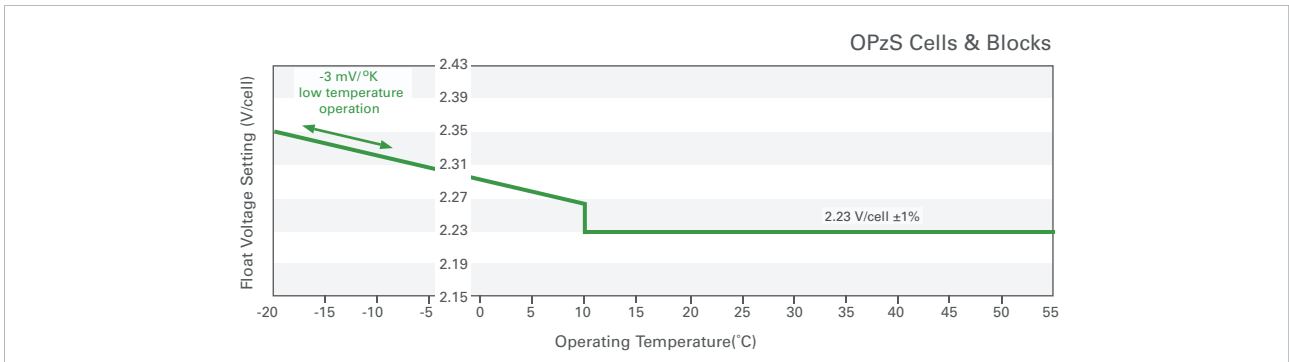

Discover® attempts to ensure the correctness of the product description and data contained herein. We reserve the right to change designs, specifications and pricing at any time without notice or obligation. It is the responsibility of the reader of this information to verify any and all information presented herein.