

Tubular Gel OPzV Cell

Discover[®] Tubular Gel OPzV batteries are maintenance-free and provide superior deep cycling performance and reliability for demanding commercial, industrial and residential applications. Providing reliable energy storage for Stationary Backup and Telecom Networks, and Renewable Energy applications with its Advanced Tubular Plate Technology to deliver long service life. Discover[®] Tubular Gel OPzV batteries provide maximum efficiency per discharge-charge cycle, and proven reliability in remote, high temperature, or unstable power network installations.

MECHANICAL DRAWINGS

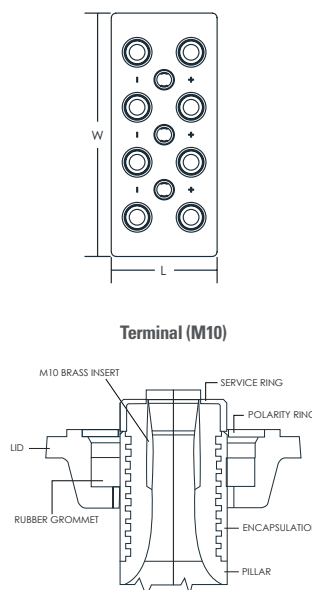
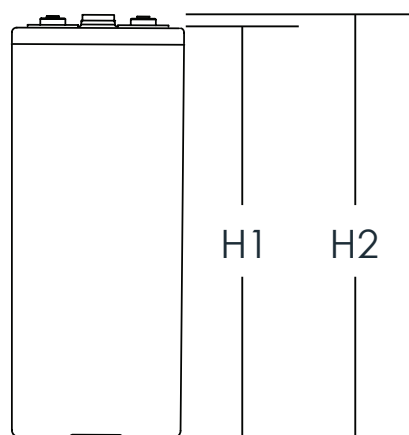

MECHANICAL SPECIFICATIONS

Voltage	2	
Industry Reference	Tubular Gel OPzV	
Length (A)	8.4 in	214 mm
Width (B)	22.8 in	578 mm
Height (C)	30.9 in	784 mm
Total Height (D)	31.9 in	809 mm
Weight	520 lbs	236 kgs
Terminal	M10	
Poles	8	
Cell(s)	1	
Container	ABS	

ELECTRICAL SPECIFICATIONS

Reference LVD / I10	20% DOD	2.05V
	50% DOD	1.97V
	80% DOD	1.91V
Cycle Life	20% DOD	7000 cycles
	50% DOD	2950 cycles
	80% DOD	1900 cycles
Internal Resistance		0.11 mΩ
Short Circuit		17300 A
Self Discharge		2-3% per month
Maximum Operating Temperature		-35°C / -31°F 50°C / 122°F
Electrolyte		Gel

ELECTRICAL SPECIFICATIONS

240 HR	120 HR	100 HR	20 HR	10 HR	5 HR	3 HR	1 HR
1.85 Volts Per Cell (VPC)			1.75 Volts Per Cell (VPC)				
4857 AH	4833 AH	4769 AH	3861 AH	3510 AH	3185 AH	-	-

NOTE: All Electrical Specifications are based on 20°C / 68°F temperature.

BENEFITS & FEATURES

Long Service Life
Tubular positive plates with non-woven polyester gauntlets are designed to prevent active material plate shedding and provide the highest cycling expectancy amongst lead acid technologies, particularly in PSoC (Partial State of Charge) operation.

High energy density tubular plates in combination with lead calcium alloy reduces self discharge and charge current requirements during float operation and extends battery service life.

Performance and Reliability
Special sliding pole terminals are designed to accommodate natural grid growth occurrence throughout battery lifetime. Battery containers are made of Acrylonitrile Butadiene Styrene (ABS) and Styrene Acrylonitrile (SAN) to endure high impact and heat environments.

Maintenance and Optimization
OPzV Gel batteries are valve-regulated, non-spillable and completely maintenance-free and available with the option to be horizontally mounted.

Safety
All products are tested and certified to multiple international safety standards for use in Photovoltaic and Stationary applications. Flame retardant containers are available upon request.

Lowest Total Cost of Ownership
OPzV Tubular batteries provide the Lowest Total Cost of Ownership (TCO) amongst lead acid technologies. Further savings can be achieved in Hybrid systems through diesel abatement and peak shaving.

CERTIFIED QUALITY

Discover and its manufacturing facilities are fully certified to ISO 9001/14001 and OSHA 18001 standards. OPzS and OPzV Tubular products are also tested in compliance to multiple international standards:

- Eurobat "Long Life" classification
- IEC 60896-21/22 (OPzV) and IEC60896-11 (OPzS) test standard for stationary applications
- IEC 61427 test standard for photovoltaic energy systems
- EN50272-1 and EN50272-2 safety requirements
- DIN 40742 (OPzV) and DIN 40736 (OPzS) standard for stationary tubular plate cells
- UN 2800 (US DOT Compliance)



EXPECTED NUMBER OF CYCLES IN RELATION TO THE DEPTH OF DISCHARGE

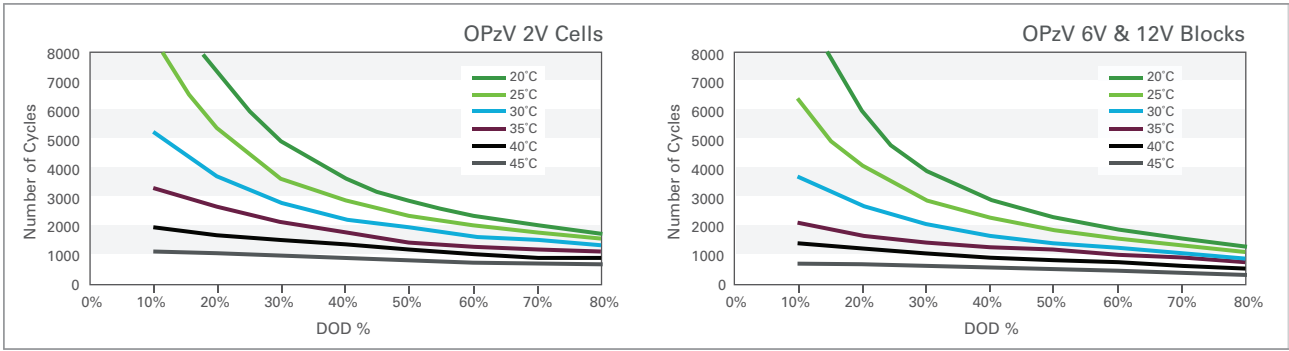

CAPACITY IN RELATION TO THE TEMPERATURE

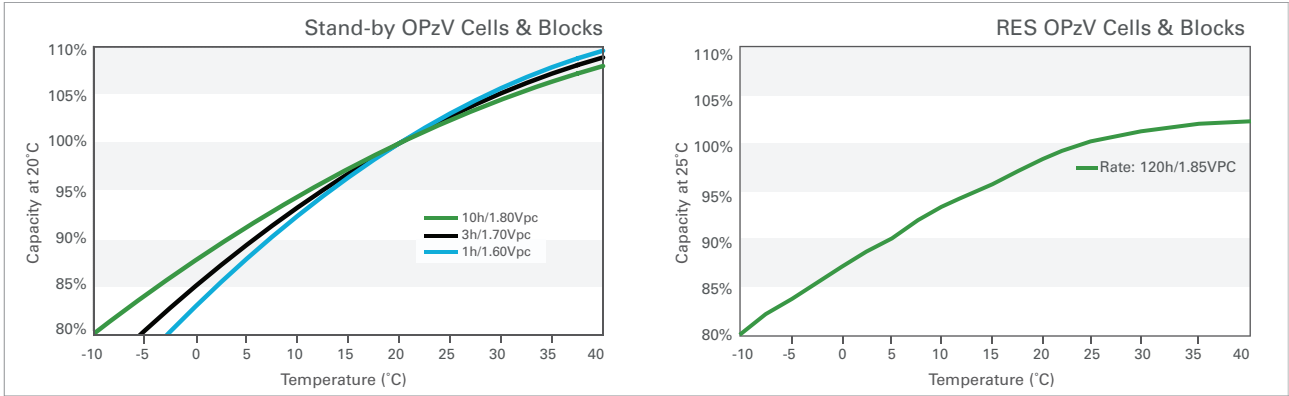

SELF-DISCHARGE CHARACTERISTICS

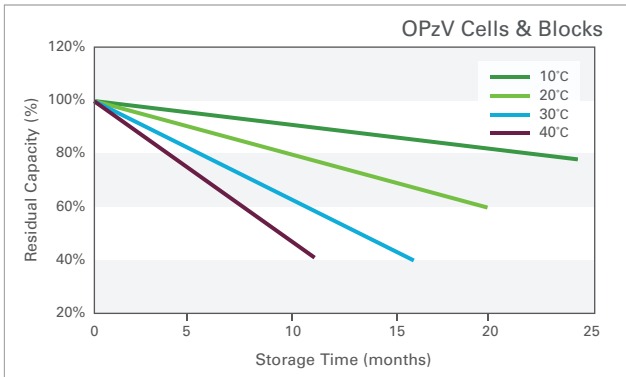

EXPECTED SERVICE LIFE IN RELATION TO OPERATING TEMPERATURE

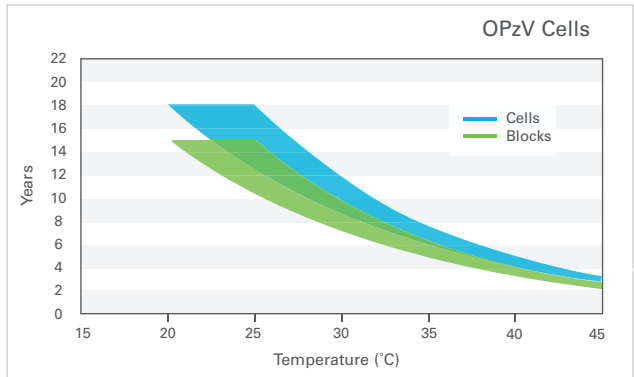

Float Voltage Setting in Relation to Operating Temperature

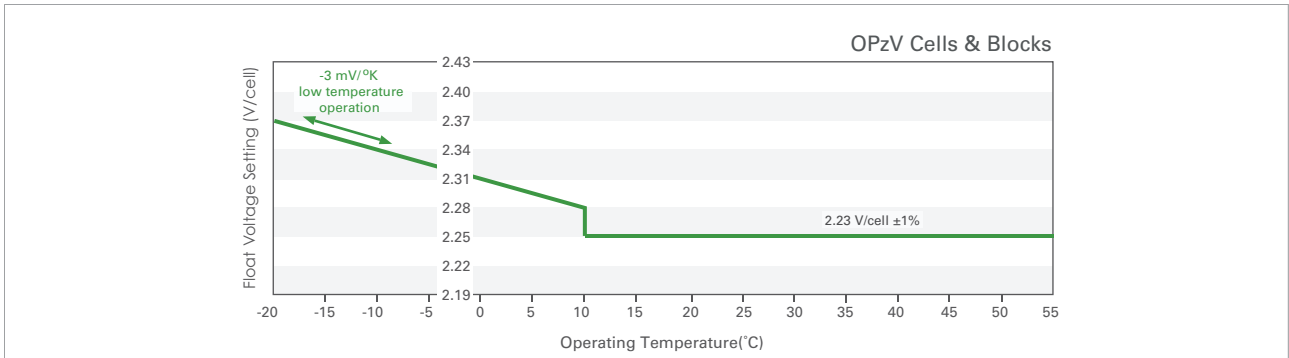

Discover® attempts to ensure the correctness of the product description and data contained herein. We reserve the right to change designs, specifications and pricing at any time without notice or obligation. It is the responsibility of the reader of this information to verify any and all information presented herein.