

Valve Regulated Lead Acid Battery

Discover[®] AGM Series VRLA Industrial Batteries provide superior high integrity and reliability for commercial, industrial, and private applications. The maintenance-free Valve Regulated Lead Acid (VRLA) construction make Discover[®] Standard AGM Series Batteries the definitive choice for mobility and Home Medical Equipment (HME), solar and renewable energy, electronics and security, marine and RV, and utility applications.

MECHANICAL DRAWINGS

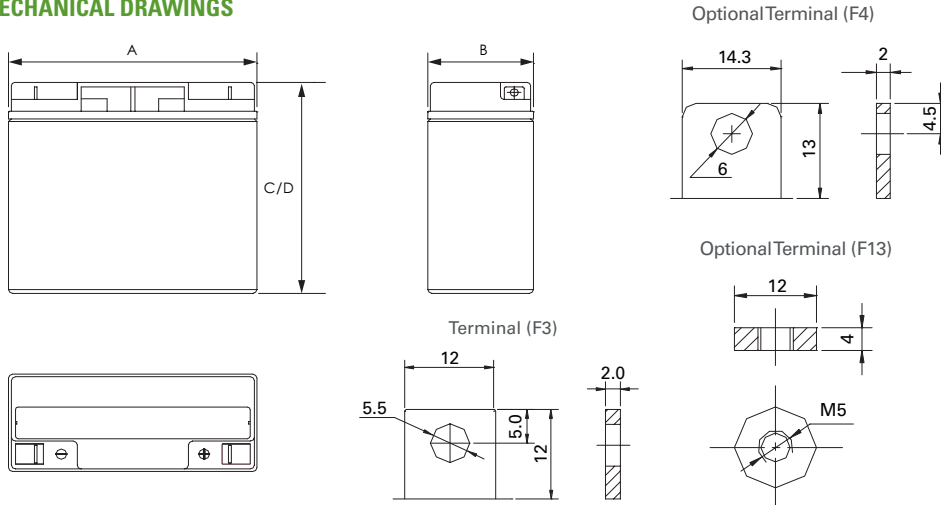

MECHANICAL SPECIFICATIONS

Length (A)	7.1 in	181 mm
Width (B)	3 in	77 mm
Height (C)	6.6 in	167 mm
Total Height (D)	6.6 in	167 mm
Weight	13.6 lbs	6.15 kgs
Terminal (Opt'l)	F3 (F4) (F13)	
Cells	6	
Electrolyte	AGM	

NOTE: There is a tolerance of +/-2%.
TERMINAL TORQUE: Please refer to our document, located in the Resources webpage (discoverbattery.com/resources).
CAUTION*: Extra considerations must be given to depths of discharge, operating voltages and currents when designing systems for use at maximum temperatures.

ELECTRICAL SPECIFICATIONS

Voltage	12 V
Internal Resistance	11 mΩ
Short Circuit 20°C (68°F)	-
20 HR	22.0 Ah
10 HR	21.0 Ah
5 HR	18.7 Ah
1 HR	15.0 Ah
15 MIN	-
Charge Temperature	-10°C (14°F) to 50°C (122°F)
Discharge Temperature	-20°C (-4°F) to 50°C (122°F)
Maximum Discharge*	-40°C (-40°F) to 60°C (140°F)

DISCHARGE CONSTANT CURRENT (AMPERES AT 25°C/77°F)

Final Voltage (VPC)	5 MIN	10 MIN	15 MIN	30 MIN	1 HR	3 HR	5 HR	10 HR	20 HR
1.60V	75.0	53.5	42.5	24.5	14.0	5.60	3.60	1.81	1.02
1.65V	72.7	52.5	41.7	23.9	13.7	5.48	3.54	1.79	1.02
1.70V	70.3	51.4	40.8	23.3	13.4	5.35	3.47	1.77	1.01
1.75V	67.8	50.2	39.9	22.6	13.0	5.20	3.40	1.75	1.00
1.80V	65.1	48.9	38.9	21.8	12.6	5.05	3.30	1.72	0.98

DISCHARGE CONSTANT POWER (WATTS AT 25°C/ 77°F)

Final Voltage (VPC)	5 MIN	10 MIN	15 MIN	30 MIN	45 MIN	1 HR	2 HR	3 HR	5 HR
1.60V	145	102	80.5	46.5	34.5	27.5	15.3	11.0	7.10
1.65V	141	100	79.0	45.5	33.9	27.1	15.1	10.8	7.00
1.70V	136	97.5	77.2	44.4	33.2	26.7	14.8	10.6	6.90
1.75V	130	95.0	75.2	43.2	32.5	26.2	14.5	10.4	6.80
1.80V	123	92.0	73.0	41.7	31.7	25.7	14.1	10.2	6.65

BENEFITS & FEATURES

Optimized lead calcium plate technology deliver high power density and consistent performance.

Special grid alloy and paste formula to reduce gassing and self-discharge.

Sealed valve regulated non-spillable maintenance-free technology.

99% gas recombination for extended life in float or cyclic applications.

Multiple battery terminal options and carrying handles.

UL924 recognized flame arresting low pressure safety vents.

Flame retardant ABS case and cover with UL94 V0 rating available.

Up to 12 year design life in float service models.

98% recyclable.

Classified as a non-spillable battery and is not restricted for transportation by:

- Air (IATA/ICAO provision 67)
- Ground (STB, DOT-CFR-HMR49)
- Water (per IMDG amendment 27)

CERTIFIED QUALITY

Discover[®] and its facilities and products are tested and certified to multiple standards:

- ISO, UL, CE, and QS standards
- ETTTS Germany
- Euro Bat classification for Environmental Stewardship Standards

Designed in accordance with and published in compliance with applicable BCI, IEC and BS EN standards, including:

- IEC60896-21/22
- BS EN 60254-1:2005
- AS/NZS 4029.2:2000



CHARGE AND DISCHARGE

Max Charge / Discharge Currents	Peak (5 seconds)	Peak (10 seconds)	Max Continuous
Charge	1c20	0.75c20	0.25c20
Discharge	15c20	10c20	0.5c20

Note 1 - Float (Stand-By) Use: Hold a constant voltage of 2.25vpc to 2.30vpc continuously. When held at this voltage, the battery will seek its own current level and maintain itself in a fully charged condition.

Note 2 - Cyclic Use: Limit initial currents to 0.25C20 amps. Charge until battery voltage reaches 2.40 to 2.45vpc. Hold at 2.40 to 2.45vpc until current drops to under 0.01C20 amps. Battery is fully charged under these conditions, and charger should be disconnected or switched to "float" voltage.

Note 3 - Temperature Coefficient: For temperatures below 25°C, adjust +0.005VPC/°C (or 0.003VPC per °F). For temperatures above 25°C, adjust -0.005VPC/°C (or 0.003VPC per °F).

DISCHARGE CHARACTERISTICS

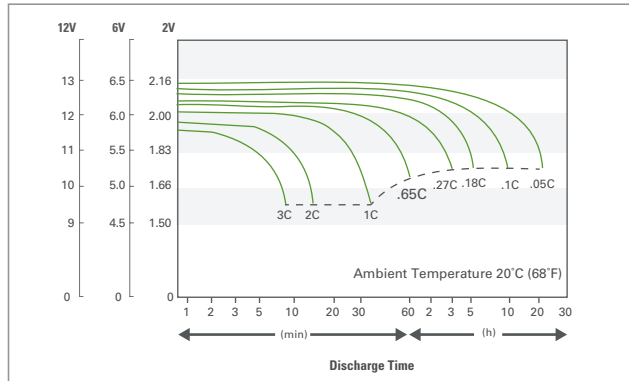

SELF-DISCHARGE CHARACTERISTICS

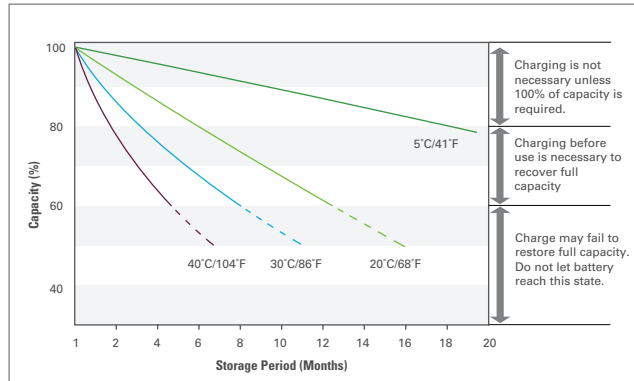

LIFE CHARACTERISTICS IN STAND-BY USE

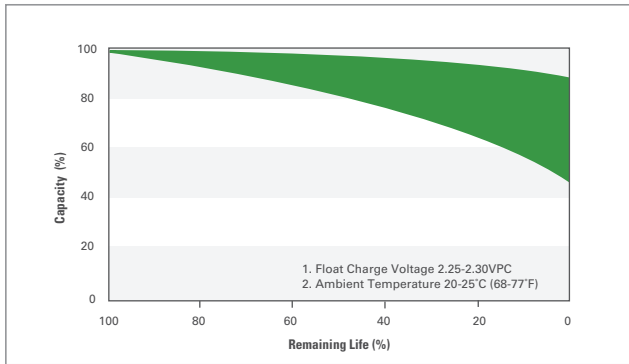

LIFE CHARACTERISTICS IN CYCLIC USE (CYCLIC MODELS ONLY)

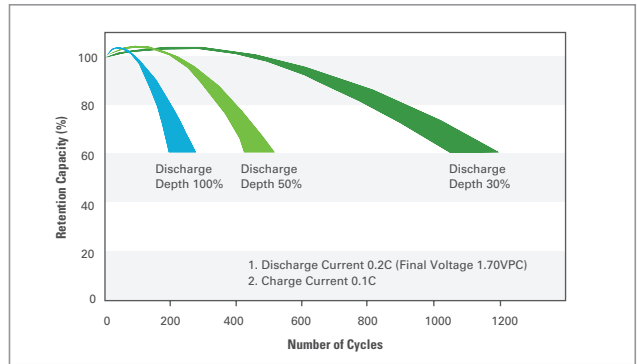

TEMPERATURE EFFECTS ON CAPACITY

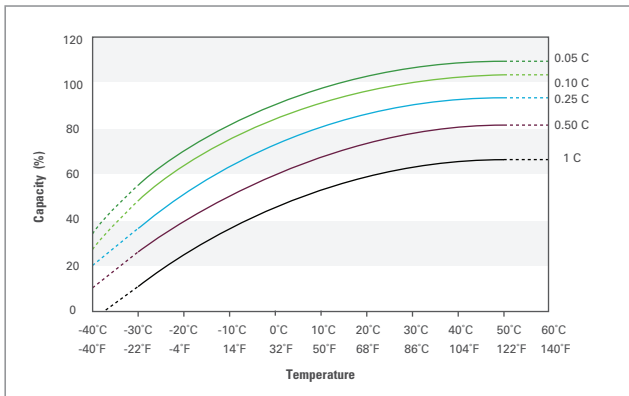

TEMPERATURE EFFECTS ON FLOAT LIFE

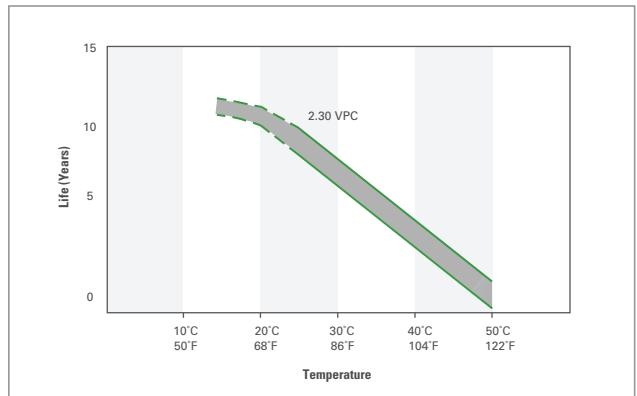

STANDBY/FLOAT APPLICATIONS

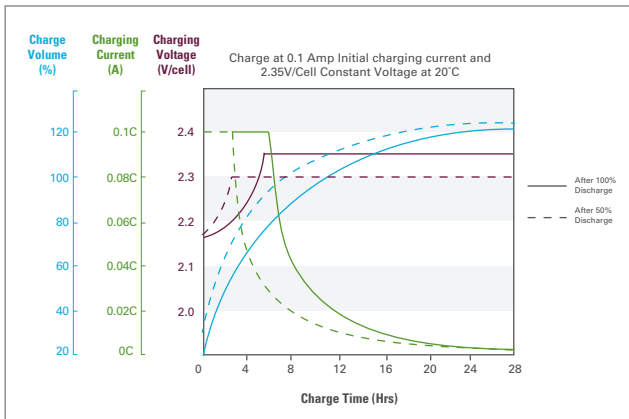

See Note 1

CYCLIC APPLICATIONS

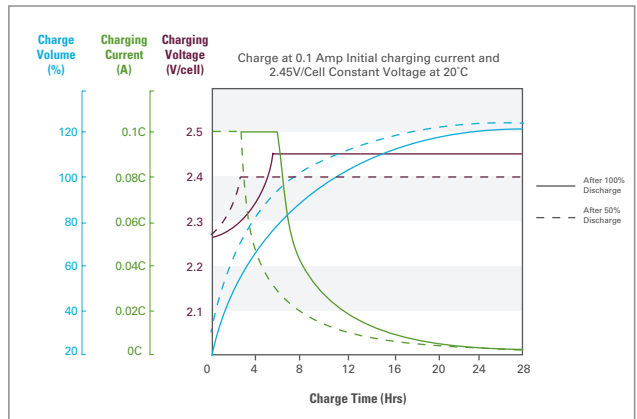

See Note 2