

# Operating Manual For Motive Power Applications

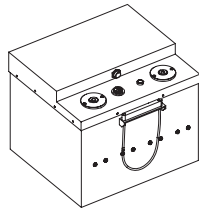

**14-24-2800**

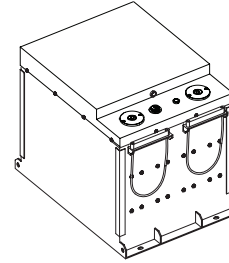

**12-36-6700**  
**12-48-6650**

<b>1. SAFETY</b>	<b>2</b>	<b>6. OPERATION</b>	<b>9</b>
1.1 Warnings, Cautions, Notes and Symbols	2	6.1 On-Off / Reset	9
1.2 General Warning	2	6.2 Charging	9
1.3 Fire Risk	2	6.3 Open Loop Charge Curve	10
1.4 Electric Shock Risk	2	6.4 Discharging	10
1.5 Chemical Risk	3	6.5 Storage	11
1.6 Do's	3	<b>7. SERVICE &amp; MAINTENANCE</b>	<b>11</b>
1.7 Do Not's	3	7.1 Warranty Registration	11
1.8 Transportation	3	7.2 Inspection	11
<b>2. BATTERY OPERATING LIMITS</b>	<b>4</b>	7.3 Battery Firmware	11
2.1 Maximum Battery Operating Limits	4	<b>8. RECYCLING AND DISPOSAL</b>	<b>11</b>
2.2 Current Protections	4	<b>9. 14-24-2800 TECHNICAL SPECIFICATIONS</b>	<b>12</b>
2.3 2.3 Recommended Battery Operating Limits for High AC Ripple Applications	4	<b>10. 12-36-6700 TECHNICAL SPECIFICATIONS</b>	<b>13</b>
<b>3. DESIGN FEATURES &amp; COMPONENTS</b>	<b>5</b>		
3.1 Integrated Battery Management System (BMS)	5		
3.2 Internal Battery Fuse	5		
3.3 Protections	5		
<b>4. HANDLING</b>	<b>6</b>		
<b>5. INSTALLATION</b>	<b>6</b>		
5.1 Tools	6		
5.2 Battery Location	6		
5.3 Securing Battery	7		
5.4 Installation	7		
5.5 Parallel Battery Wiring	8		
5.6 Commissioning Parallel Systems	8		
5.7 Configuration with Power Conversion and Monitoring Devices	9		



## 1. SAFETY

### 1.1 Warnings, Cautions, Notes and Symbols

<b>▲ WARNING</b>
Important information regarding possible personal injury.
<b>▲ CAUTION</b>
Important information regarding possible equipment damage.
<b>▲ NOTE</b>
Additional information concerning important procedures and features of the battery.

### 1.2 General Warning

<b>▲ CAUTION</b>
It is important to operate the device with care to avoid undesirable consequences.



Do not throw in the garbage. Do not dispose in fire.



Use personal protective equipment when working with batteries.



**WARNING** -To reduce the risk of injury, user must read instruction manual. Read all the instructions before installation, operation and maintenance.



This product must be recycled and is made of recycled products.

<b>▲ CAUTION</b>
Do not disassemble or modify the battery. If the battery housing is damaged, do not touch exposed contents.

### 1.3 Fire Risk

<b>▲ WARNING</b>
Risk of fire - No user serviceable parts.

- Battery has a Battery Management System (BMS) with integrated solid state relay to reduce fire risk.
- Primary suppression for lithium battery fires is water, the secondary suppression is CO2 powder and halon.

### 1.4 Electric Shock Risk

<b>▲ WARNING</b>
For wet and electrically uninsulated working conditions, electric shock risk is high, and can cause injury and death.



Model	Nominal System Voltage	Maximum System Voltage
14-24-2800	24 V	29.2 V
12-36-6700	36 V	43.8 V
12-48-6650	48 V	58.4 V

### 1.5 Chemical Risk

**▲ WARNING**

Lithium batteries are a chemical risk if misoperated, mishandled or abused.

### 1.6 Do's

- Do protect terminals from short circuit before, during, and after installation
- Do wear electrically insulated gloves
- Do use electrically insulated tools
- Do wear eye protection
- Do wear safety toe boots / shoes
- Do handle battery carefully
- Do secure battery safely
- Do always assume battery terminals are energized

### 1.7 Do Not's

- Do not immerse battery in water
- Do not lift or carry the battery during usage or operation
- Do not operate or store battery outside of operating limits
- Do not short circuit battery
- Do not puncture battery
- Do not expose battery to flames, or incinerate
- Do not open battery case or disassemble battery
- Do not wear rings, watches, bracelets or necklaces when handling or working near battery
- Do not drop or crush battery
- Do not lift battery by the terminal cables
- Do not vibrate battery
- Do not expose battery to water or other fluids
- Do not expose battery to direct sunlight
- Do not dispose of battery
- Do not connect with other types of batteries
- Do not expose battery to high temperatures
- Do not install with other battery types or brands

### 1.8 Transportation

If the battery is not installed in equipment, it must be transported in the original package or equivalent.

Batteries are tested according to UN Handbook of Tests and Criteria, part III, sub section 38.3 (ST/SG/AC. 10/11/Rev.5). For transport the batteries belong to category UN3480, Class 9, Packaging Group II.



## 2. BATTERY OPERATING LIMITS

### 2.1 Maximum Battery Operating Limits

The battery should not be operated outside the Maximum Operating Limits, the BMS will open its internal relay and disconnect the battery if any of the following limits are exceeded.

Maximum Operating Limits	14-24-2800	12-36-6700	12-48-6650
Continuous Charge Current*	110 Adc	150 Adc	130 Adc
Continuous Discharge Current*	110 Adc	150 Adc	130 Adc
Charge Voltage	27.2 V	40.8 V	54.4 V
Operating Voltage (Min / Max)	22.4 V / 29.2 V	33.6 V / 43.8 V	44.8 V / 58.4 V
Charge Temperature (Min / Max)	0°C / 45°C (32°F / 113°F)		
Discharge Temperature (Min / Max)	-20°C / 50°C (-4°F / 122°F)		
Storage Temperature (Min / Max)	-20°C / 45°C (-4°F / 113°F)		

\* Effects of AC Ripple must be taken into consideration when sizing and configuring your system.

### 2.2 Current Protections

The programmed over current protections of the BMS follow the curves seen in the next two figures:

#### High Current Interrupt Time (100-150%)

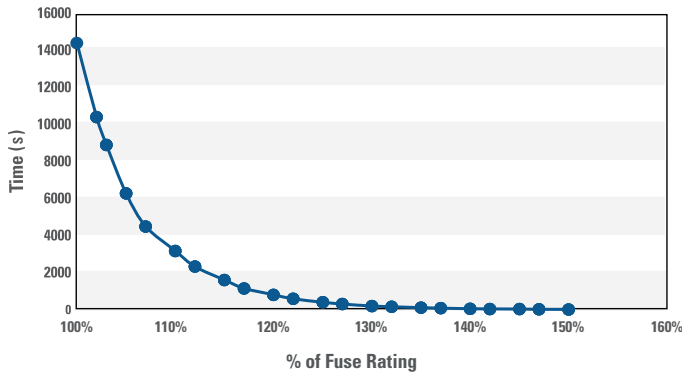

#### High Current Interrupt Time (200-600%)

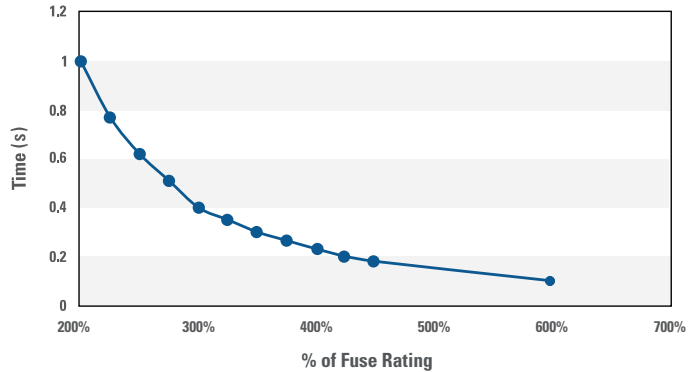

**▲ NOTE!**

Intentional bypassing of BMS to operate the battery outside maximum and minimum limits voids warranty.

### 2.3 Recommended Battery Operating Limits for High AC Ripple Applications

The battery maximum operating limits are specified for DC current and voltage and do not account for AC ripple typically caused by frequency conversion electronics such as inverter/chargers. The following operating limits are recommended for these types of systems.



Recommended Operating Settings	14-24-2800	12-36-6700	12-48-6650
Max Continuous Charge Current	< 78 A	< 106 A	< 92 A
Max Continuous Discharge Current	< 78 A	< 106 A	< 92 A
Charge Voltage (Bulk/Absorb)	27.2 V	40.8 V	54.4 V
Charge Voltage (Float)	26.8 V	40.2 V	53.6 V
Low Voltage Disconnect	24 V	36 V	48 V
Operating Temperature	20°C (68°F)		

### 3. DESIGN FEATURES & COMPONENTS

#### 3.1 Integrated Battery Management System (BMS)

##### Monitors

- Cell module voltage
- Battery voltage
- Battery current
- Battery temperature
- Battery state of charge (SOC)
- Battery energy throughput

##### Module Balancing

- Performs balancing of cell modules

##### Protection and Operating Limits

- BMS will open its internal relay when maximum operating limits are exceeded
- When the condition returns to its nominal operating range, most protections will be released and reset after 120s

##### Communication Ports

- Isolated USB and CAN communication

##### Data Logging

- Logged data is accessed using AES Dashboard software via the USB port (Win64\_supported)

#### 3.2 Internal Battery Fuse

The internal battery fuse provides back-up over-current protection. External fusing should be sized correctly to protect the circuit and circuit cabling.

- A blown fuse requires replacement by a qualified installer - contact your Discover Energy Systems installer.

#### 3.3 Protections

The BMS will open the internal relay to protect against operation outside of maximum specifications. During a protection the key LED will flash at 1 Hz (Hardware version 0.0.0.1 models will sound a buzzer, but not flash the key LED). Most protections will automatically recover once the condition is cleared with the exception of the low voltage protection.



Protection	Auto Recoverable	Description
Over Voltage	Yes	Protection is triggered when any cell module voltage exceeds the threshold value for 5 seconds. After the voltage falls below the trigger for 120 seconds the protection is cleared.
Under Voltage	No	Protection is triggered when any cell module voltage falls below the threshold value for 5 seconds. The battery will turn itself off after 120s.
High Current	Yes	Protection is triggered when current exceeds the threshold value. The protection will be cleared after 120 seconds.
High Temperature	Yes	Protection is triggered when the battery temperature exceeds the threshold value for 5 seconds. After the temperature falls below the recovery temperature the protection is cleared.
Low Temperature	Yes	Protection is triggered when the battery temperature falls below the threshold value for 5 seconds. After the temperature raises above the recovery temperature the protection is cleared.

#### 4. HANDLING

**▲ WARNING!**  
Read Safety Section before installing the battery.

- Battery should be set to OFF
- Battery cables should be disconnected
- Battery terminals should be protected
- Battery handle should be used to lift battery
- Battery should be handled by two people or mechanical lift equipment
- Do not lift or carry the battery during usage or operation

#### 5. INSTALLATION

**▲ WARNING!**  
Read Safety Section before installing the battery.

**▲ CAUTION!**  
Do not install AES LiFePO<sub>4</sub> batteries in series. Select the appropriate AES battery model for the voltage of your system.

##### 5.1 Tools

- Insulated tools sized to match nuts, bolts and cables in use
- Voltmeter
- Post cleaner and wire brush
- Personal protective equipment

##### 5.2 Battery Location

Locate the batteries close to the power conversion device in order to minimize the length of the battery cables. Care should be taken to ensure adequate clearance above the batteries is maintained for access to both battery and power conversion device connections and disconnects.

Protection from exposure to water, including water sprayed from nozzles, should be ensured.



AES Battery performance and service life will be optimized when they are operated in an ambient temperature of 15°C to 25°C (59°F to 77°F). Care should be taken to ensure that the battery's temperature is > 0°C (32°F) during charging.

### 5.3 Securing Battery

- Battery can be strapped in place with non-conductive nylon straps
- 12-36-6700 and 12-48-6650 models have hold down brackets at the base of the battery (figure below)

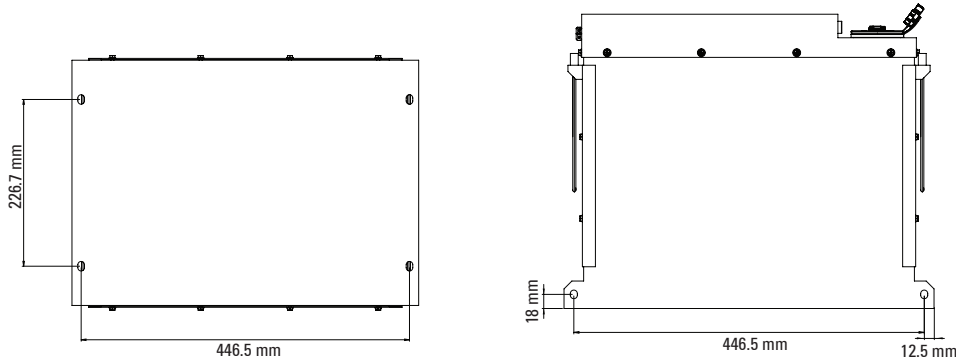

### 5.4 Installation

Battery cables must be sized to the specifications required by the inverter charger, and must be installed in accordance with the standards set by the authority having local jurisdiction. Do not use or install a battery temperature sensor.

- Confirm that battery is set to OFF
- If the battery circuit has a disconnect - open the disconnect to isolate battery
- Cable connection points should always be kept clean
- Broken, frayed, brittle, kinked or cut cables should never be used
- Secure the new battery - be careful not to ground the terminals to any metal mounting, fixture, or body part
- Connect battery cables - connect the ground cable last to avoid sparking
- Terminals are button-type, M8 female - recommended torque is 9.0 Nm (6.64 ft-lb)
- Inspect the battery cables to ensure they have not been installed in reverse polarity
- If the battery circuit has a disconnect - close disconnect to reconnect the battery
- Set the battery to ON

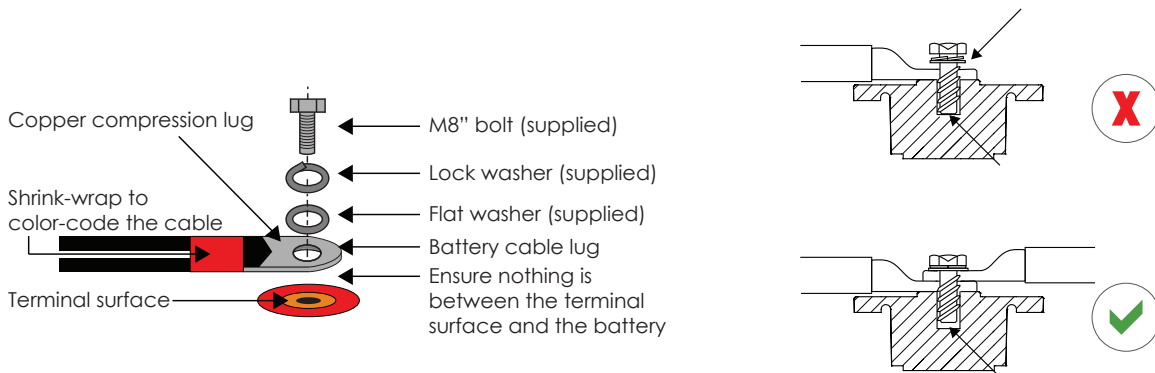

**▲ NOTE!**

All cable ends must be connected to battery terminals without any washers between terminal bushings and cable ends.

Terminal burnout is caused by:

- Discharge currents exceeding allowable limits
- Improper cable installation
- Improper cable sizing
- Improper terminal torque

**▲ NOTE!**

Without exception, product experiencing terminal burn out will not be warranted.

### 5.5 Parallel Battery Wiring

To ensure proper balancing and load sharing between parallel batteries refer to the wiring diagram below. Lithium batteries are very sensitive to voltage and undersized battery cables will limit battery and system performance. The thickness (cross section) of cable used should exceed the recommended minimum for the inverter charger installation whenever possible.

Five or more batteries in parallel should be installed using a busbar configuration. In a busbar configuration all battery cable sets should be the same length regardless of the battery's proximity to the busbar (or combiner box). Actual wiring requirements may vary. Consult with the authority having local jurisdiction.

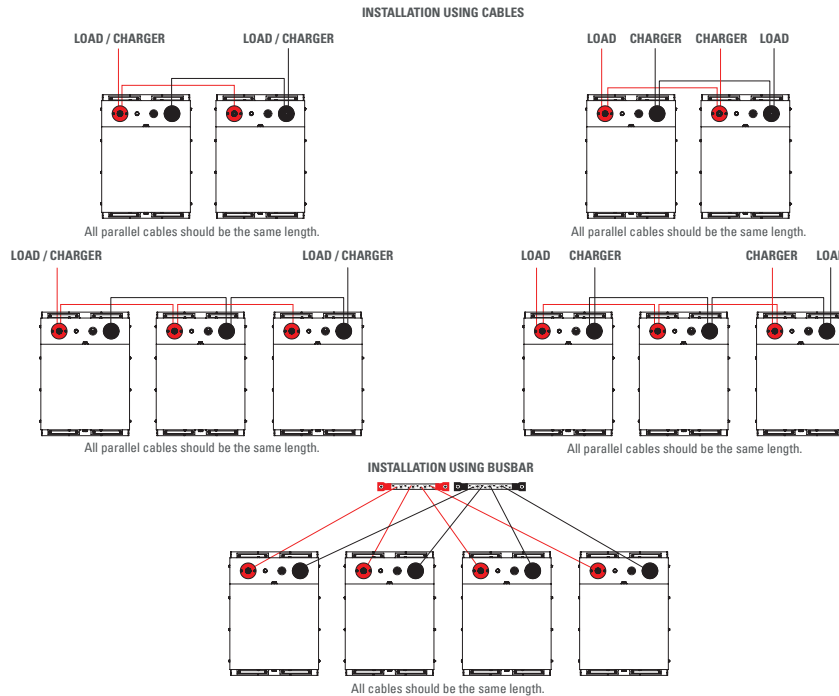

### 5.6 Commissioning Parallel Systems

When commissioning a system with parallel batteries ensure that all batteries are charged to 100% State of Charge (SOC) before setting all batteries to ON.





**▲ CAUTION!**

Failure to ensure all batteries are at equal SOC when commissioning a paralleling system may result in blown battery fuses.

Before energizing power electronics ensure that all batteries are set to ON.

### 5.7 Configuration with Power Conversion and Monitoring Devices

AES batteries must be set up to work with the Power Conversion devices in either an Open Loop or Closed Loop configuration. The charge and discharge settings in a Open Loop configuration are set up through the controller of the Power Conversion device at the time of installation. In a Closed Loop configuration, charge and discharge settings are dynamically controlled by the BMS of the AES Battery over a connection with the Power Conversion device network. Charge sources with compliant J1939 Canbus communications can be used directly with AEBus. All other Closed Loop communication with a Power Conversion device network requires the use of a LYNK Gateway Communication device available from Discover Energy Systems.

For Closed Loop and Open Loop configuration details please refer to the appropriate Application Note for your Power Conversion device available from the Discoverlithium.com website, or contact your Discover Energy Systems provider for assistance.

## 6. OPERATION

**▲ NOTE!**

Review operating limits.

### 6.1 On–Off / Reset

- To set the battery to ON momentarily press the button - the LED will illuminate
- To set the battery to OFF momentarily press the button - the LED will darken



### 6.2 Charging

Before charging the battery make sure to read and understand the instructions that come with the Power Conversion device. Never attempt to charge a battery without first reviewing and understanding the instructions for the Power Conversion device being used. Do not use or install a battery temperature sensor.

**▲ CAUTION!**

Always make sure the chargers charging curve meets the battery's charging requirement; never charge a visibly damaged battery; never charge a frozen battery.

1. Connect the Power Conversion device's charger leads to the battery.
2. Ensure the charger and battery side connections are tight.
3. Set the charger to ON
4. Set the battery to ON

**▲ CAUTION!**

**NOT ALL CHARGERS ARE CAPABLE OF CHARGING LITHIUM BATTERIES**  
**CONFIRM** that your chosen charger is incapable of producing transient spikes that exceed the published terminal voltage limits for the battery.



Spikes are fast, short duration electrical transients in voltage (voltage spikes), current (current spikes), or transferred energy (energy spikes) in an electrical circuit. Voltage spikes usually happen when the AC/DC adapter is plugged in, or charge current is cut off quickly. Multi voltage chargers are constructed using transformers that may be capable of producing spikes that exceed the maximum ratings of the Discover Energy Systems AES Battery. You must ensure that the charger being supplied:

- Meets the recommended charge curve
- Incapable of exceeding Discover’s maximum terminal voltages

### 6.3 Open Loop Charge Curve

1. Charge at constant current to 3.4V per cell module (Bulk).
2. Maintain constant voltage 3.4V per cell module (Absorption).
3. Terminate when charge current drops below 2A.
4. Optional Float at 3.35V per cell module (Float).

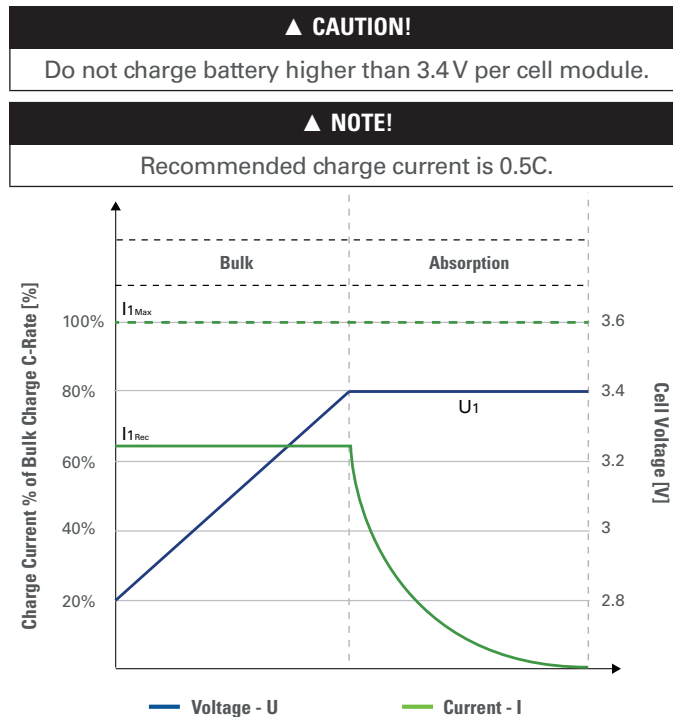

Model	Cell Modules in Series	Bulk Current	Absorption Voltage	Termination Charge Current
14-24-2800	8S	110 Adc maximum	27.2 V	I <sub>2</sub> ≤ 2 A
12-36-6700	12S	150 Adc maximum	40.8 V	
12-48-6650	16S	130 Adc maximum	54.4 V	

### 6.4 Discharging

- Set the battery to ON
- Set the load to ON
- Recommended low voltage cut off: 24 V | 36 V | 48 V



**▲ NOTE!**  
Do not discharge battery below recommended minimum operating voltages.

**▲ NOTE!**  
Do not discharge battery at rates greater than recommended operating currents.

**6.5 Storage**

Systems should be stored out of direct sunlight under the following temperature conditions:

Minimum Storage Temperature	-20°C / -4°F
Maximum Storage Temperature	45°C / 113°F

Systems should be put into storage at 80% SOC and checked monthly to ensure SOC does not fall below 20%.

At 20% SOC the battery will self discharge in approximately 2 months.

**▲ CAUTION!**  
Do not store a discharged battery. Recharge battery after every use. Batteries that have self-discharged to a severely discharge state are not recoverable.

**7. SERVICE & MAINTENANCE**

**7.1 Warranty Registration**

To register your product you will need the serial number of the battery. Visit [discoverlithium.com](http://discoverlithium.com) for registration details.

**7.2 Inspection**

Batteries should be carefully inspected on a regular basis in order to detect and correct potential problems before they do harm. This routine should be started when the batteries are first received.

- Inspect for cracks in the battery casing
- Check battery terminals and connections to make sure they are clean, free of dirt, fluids and corrosion
- All battery cables and their connections should be tight, intact, and NOT broken or frayed
- Replace any damaged batteries
- Replace any damaged cables
- Ensure correct torque is used for the terminal bolts

**7.3 Battery Firmware**

Consult the [discoverlithium.com](http://discoverlithium.com) website for the latest battery firmware versions. If a battery firmware update is require, ensure this is done by a qualified and authorized person using the AES Dashboard software tool.

**8. RECYCLING AND DISPOSAL**

Batteries must not be mixed with domestic or industrial waste. Discover AES batteries are recyclable and must be processed through a recognized recycling agency or dealer. Please contact Discover or your servicing dealer for details.



## 9. 14-24-2800 TECHNICAL SPECIFICATIONS

Electrical Specifications		
Nominal Voltage	25.6 V	
Charge Voltage	27.2 V	
Maximum Voltage	29.2 V	
Minimum Voltage	20 V	
Nominal Capacity	110 Ah	
Nominal Energy	2816 Wh	
Max Continuous Charge Current	110 A <sub>dc</sub>	
Max Continuous Discharge Current	110 A <sub>dc</sub>	
Fuse - Provides backup over-current protection	Hardware 0.0.0.1	150 A
	Hardware 0.0.0.2	200 A
Cell Chemistry	LiFePO <sub>4</sub>	
Cell Modules	8S 22P	
Self-Discharge 25°C / 77°F	< 3% per month (battery off)	

Fault Limits	
OverTemperature - Discharge Protection	> 60°C/140°F for 5s
OverTemperature - Charge Protection	> 60°C/140°F for 5s
LowTemperature - Discharge Protection	< -20°C/-4°F for 5s
LowTemperature - Charge Protection	< 0°C/32°F for 5s
Over Voltage Protection	> 3.65 V in any cell module for 5s
Under Voltage Protection	< 2.5 V in any cell module for 5s
Over Current Protection	Based on Fuse (Section 2.2)

Mechanical Specifications	
Battery Dimensions (HxWxD)	276 x 347.5 x 329.5 mm
Battery Weight	40 kg
Shipping Dimensions (HxWxD)	470 x 430 x 390 mm
Shipping Weight	48.4 kg
Terminal	M8
Terminal Hardware	M8 Stainless Steel Bolt, Flat Washer, Lock Washer (Supplied)
Terminal Torque	9.0 Nm +/- 3
Case Material	Powder Coated Cold Rolled Steel
Enclosure IP Rating	IP 55
Charge Temperature Range	0°C/45°C (32°F/113°F)
Discharge Temperature Range	-20°C/50°C (-4°F/122°F)
Storage Temperature Range	-20°C/45°C (-4°F/113°F)

Operational Specifications	
Battery Management System (BMS)	Integrated, with Solid State Relay (SSR)
Cell Balancing	Passive balancing when Cell Voltage > 3.35 V
Non-Volatile Memory	Yes
Lifetime Logged Data	<ul style="list-style-type: none"> <li>• Time</li> <li>• High/low average cell module voltage</li> <li>• Balancing, Fault and Relay State</li> <li>• Battery SOC, Current, Voltage, Temperature</li> <li>• Charge Energy In/Out</li> </ul>
Communication Ports	<ul style="list-style-type: none"> <li>• Isolated USB</li> <li>• Isolated CAN (AEBus)</li> </ul>
Communication Connector	USB Type A Female Circular 12 Pin

**Circular 12 PIN**

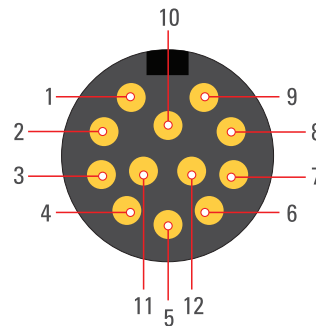

Pin 3	AEBus CAN GND
Pin 4	AEBus CAN High
Pin 5	AEBus CAN Low
Pin 6	LED GND
Pin 7	LED +5V
Pin 8	Key/Reset +
Pin 9	Key/Reset -
Pin 11	AEBus CAN +5V
Pin 12	AEBus CAN +12V (Hardware 0.0.0.2)

Regulatory Approvals	UN 38.3, IEC 62133, UL 2271, UL 1973
----------------------	--------------------------------------

**UN38.3 PASSED**  
TRANSPORT SAFETY CERTIFIED



## 10.12-36-6700 TECHNICAL SPECIFICATIONS

Electrical Specifications		
Nominal Voltage	38.4 V	
Charge Voltage	40.8 V	
Maximum Voltage	43.8 V	
Minimum Voltage	30 V	
Nominal Capacity	175 Ah	
Nominal Energy	6720 Wh	
Max Continuous Charge Current	150 Adc	
Max Continuous Discharge Current	150 Ad	
Fuse - Provides backup over-current protection	Hardware 0.0.0.1	150 A
	Hardware 0.0.0.2	200 A
Cell Chemistry	LiFePO <sub>4</sub>	
Cell Modules	12S 35P	
Self-Discharge 25°C / 77°F	< 3% per month (battery off)	

Fault Limits	
OverTemperature - Discharge Protection	> 60°C/140°F for 5s
OverTemperature - Charge Protection	> 60°C/140°F for 5s
LowTemperature - Discharge Protection	< -20°C/-4°F for 5s
LowTemperature - Charge Protection	< 0°C/32°F for 5s
Over Voltage Protection	> 3.65 V in any cell module for 5s
Under Voltage Protection	< 2.5 V in any cell module for 5s
Over Current Protection	Based on Fuse (Section 2.2)

Mechanical Specifications	
Battery Dimensions (HxWxD)	375 x 347.5 x 471.5 mm
Battery Weight	88 kg
Shipping Dimensions (HxWxD)	570 x 440 x 570 mm
Shipping Weight	99.9 kg
Terminal	M8
Terminal Hardware	M8 Stainless Steel Bolt, Flat Washer, Lock Washer (Supplied)
Terminal Torque	9.0 Nm +/- 3
Case Material	Powder Coated Cold Rolled Steel
Enclosure IP Rating	IP 55
Charge Temperature Range	0°C/45°C (32°F/113°F)
Discharge Temperature Range	-20°C/50°C (-4°F/122°F)
Storage Temperature Range	-20°C/45°C (-4°F/113°F)

Operational Specifications	
Battery Management System (BMS)	Integrated, with Solid State Relay (SSR)
Cell Balancing	Passive balancing when Cell Voltage > 3.35 V
Non-Volatile Memory	Yes
Lifetime Logged Data	<ul style="list-style-type: none"> <li>• Time</li> <li>• High/low average cell module voltage</li> <li>• Balancing, Fault and Relay State</li> <li>• Battery SOC, Current, Voltage, Temperature</li> <li>• Charge Energy In/Out</li> </ul>
Communication Ports	<ul style="list-style-type: none"> <li>• Isolated USB</li> <li>• Isolated CAN (AEBus)</li> </ul>
Communication Connectors	USB Type A Female Circular 12 Pin

**Circular 12 PIN**

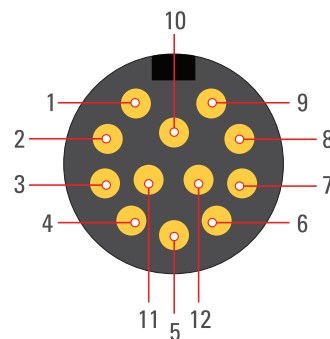

Pin 3	AEBus CAN GND
Pin 4	AEBus CAN High
Pin 5	AEBus CAN Low
Pin 6	LED GND
Pin 7	LED +5V
Pin 8	Key/Reset +
Pin 9	Key/Reset -
Pin 11	AEBus CAN +5V
Pin 12	AEBus CAN +12V (Hardware 0.0.0.2)

Regulatory Approvals	UN 38.3
----------------------	---------

**UN38.3 PASSED**  
TRANSPORT SAFETY CERTIFIED



## 11. 12-48-6650 TECHNICAL SPECIFICATIONS

Electrical Specifications		
Nominal Voltage	51.2 V	
Charge Voltage	54.4 V	
Maximum Voltage	58.4 V	
Minimum Voltage	40 V	
Nominal Capacity	130 Ah	
Nominal Energy	6656 Wh	
Max Continuous Charge Current	130 Adc	
Max Continuous Discharge Current	130 Adc	
Fuse - Provides backup over-current protection	Hardware 0.0.0.1	150 A
	Hardware 0.0.0.2	200 A
Cell Chemistry	LiFePO <sub>4</sub>	
Cell Modules	16S 26P	
Self-Discharge 25°C / 77°F	< 3% per month (battery off)	

Fault Limits	
OverTemperature - Discharge Protection	> 60°C/140°F for 5s
OverTemperature - Charge Protection	> 60°C/140°F for 5s
LowTemperature - Discharge Protection	< -20°C/-4°F for 5s
LowTemperature - Charge Protection	< 0°C/32°F for 5s
Over Voltage Protection	> 3.65 V in any cell module for 5s
Under Voltage Protection	< 2.5 V in any cell module for 5s
Over Current Protection	Based on Fuse (Section 2.2)

Mechanical Specifications	
Battery Dimensions (HxWxD)	375 x 347.5 x 471.5 mm
Battery Weight	87 kg
Shipping Dimensions (HxWxD)	570 x 440 x 570 mm
Shipping Weight	98.9 kg
Terminal	M8
Terminal Hardware	M8 Stainless Steel Bolt, Flat Washer, Lock Washer (Supplied)
Terminal Torque	9.0 Nm +/- 3
Case Material	Powder Coated Cold Rolled Steel
Enclosure IP Rating	IP 55
Charge Temperature Range	0°C/45°C (32°F/113°F)
Discharge Temperature Range	-20°C/50°C (-4°F/122°F)
Storage Temperature Range	-20°C/45°C (-4°F/113°F)

Operational Specifications	
Battery Management System (BMS)	Integrated, with Solid State Relay (SSR)
Cell Balancing	Passive balancing when Cell Voltage > 3.35 V
Non-Volatile Memory	Yes
Lifetime Logged Data	<ul style="list-style-type: none"> <li>• Time</li> <li>• High/low average cell module voltage</li> <li>• Balancing, Fault and Relay State</li> <li>• Battery SOC, Current, Voltage, Temperature</li> <li>• Charge Energy In/Out</li> </ul>
Communication Ports	<ul style="list-style-type: none"> <li>• Isolated USB</li> <li>• Isolated CAN (AEBus)</li> </ul>
Communication Connectors	USB Type A Female Circular 12 Pin

**Circular 12 PIN**

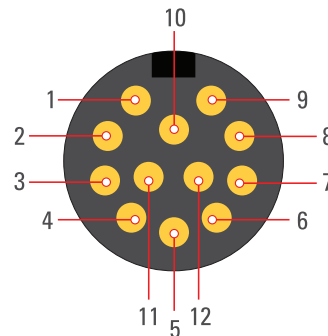

Pin 3	AEBus CAN GND
Pin 4	AEBus CAN High
Pin 5	AEBus CAN Low
Pin 6	LED GND
Pin 7	LED +5V
Pin 8	Key/Reset +
Pin 9	Key/Reset -
Pin 11	AEBus CAN +5V
Pin 12	AEBus CAN +12V (Hardware 0.0.0.2)

Regulatory Approvals	UN 38.3, IEC62133, UL 2271, UL 1973
----------------------	-------------------------------------

**UN38.3 PASSED**  
TRANSPORT SAFETY CERTIFIED



+ 1.778.776.3288

info@discoverlithium.com

#7 -13511 Crestwood Place, Richmond, BC, V6V 2E9, Canada

discoverlithium.com