

# LYNK II

(950-0025)

## INSTALLATION AND OPERATION MANUAL

<b>INTRODUCTION .....</b>	<b>3</b>
<b>1.0 AUDIENCE, MESSAGES, WARNINGS, GENERAL SAFETY, PERSONAL PROTECTIVE EQUIPMENT .....</b>	<b>3</b>
1.1 Audience .....	3
1.2 Warning, Caution, Notice, and Note Messages .....	3
1.3 General Warnings.....	4
1.4 Safe Handling Procedures .....	4
1.5 Personal Protective Equipment .....	5
<b>2.0 Documentation .....</b>	<b>5</b>
<b>3.0 About LYNK II.....</b>	<b>6</b>
3.1 Overview .....	6
3.2 Compatible Batteries and Devices.....	6
3.3 Compatible Communication Protocols.....	7
3.4 Firmware Revision .....	7
<b>4.0 Items Shipped in the Box .....</b>	<b>7</b>
<b>5.0 Design and Features .....</b>	<b>8</b>
5.1 Reset Button Operation.....	9
5.2 LED Indicators .....	9
5.3 LYNK Port Pin Assignment.....	11
5.4 Pin Assignments for Phoenix 12-pin Connector .....	11
5.5 Power Sources for LYNK II .....	12
<b>6.0 CAN Hardware Termination and CAN Out Pin Configurations .....</b>	<b>13</b>
6.1 Access to Configuration Header Boards and Jumpers .....	13
6.2 CAN Termination .....	14
6.3 CAN Out - RJ45 Header Assignments .....	16
<b>7.0 Installation.....</b>	<b>21</b>
7.1 Mounting LYNK II .....	21
7.2 Installing the External Power Source .....	21
7.3 LYNK Network Communication Cables .....	21
7.4 Verification of the LYNK Network .....	25
<b>8.0 Relay Hardware Installation .....</b>	<b>26</b>
<b>9.0 Ethernet Hardware Installation and Layout.....</b>	<b>27</b>
<b>10.0 Connecting to LYNK ACCESS .....</b>	<b>27</b>
<b>11.0 Configuring the CAN Communication with LYNK ACCESS.....</b>	<b>29</b>
<b>12.0 Configuring Ethernet Settings with LYNK ACCESS.....</b>	<b>29</b>
<b>13.0 Configuring Relays with LYNK ACCESS .....</b>	<b>29</b>
13.1 Relay Configuration - Triggers and Features .....	30
13.2 Relay Configuration - Trigger Sources and Value Ranges .....	31
13.3 Relay Configuration - Operation States.....	32
<b>14.0 Updating LYNK II Firmware with LYNK ACCESS .....</b>	<b>32</b>
<b>15.0 Specifications .....</b>	<b>33</b>

# INTRODUCTION

This document provides information about the integration and setup of LYNK II with Discover Lithium battery systems.

## 1.0 AUDIENCE, MESSAGES, WARNINGS, GENERAL SAFETY, PERSONAL PROTECTIVE EQUIPMENT

### 1.1 Audience

Qualified personnel should perform configuration, installations, service, and operating tasks in consultation with local utilities and authorized dealers. Qualified personnel should have training, knowledge, and experience in the:

- Installation of electrical equipment
- Application of applicable installation codes
- Analyzation and reduction of hazards involved in performing electrical work
- Installation and configuration of batteries
- Installation and configuration of systems activated by relays.

### 1.2 Warning, Caution, Notice, and Note Messages

#### **WARNING**

Important information regarding hazardous conditions that may result in personal injury or death.

#### **CAUTION**

Important information regarding hazardous conditions that may result in personal injury.

#### **NOTICE**

Important information regarding conditions that may result in damage to the equipment but not personal injury.

#### **NOTE**

Ad hoc information concerning important procedures and battery features not related to personal injury or equipment damage.

## 1.3 General Warnings

### WARNING

#### ELECTRIC SHOCK AND FIRE HAZARD

- A lithium battery must be installed as specified.
- Do not disassemble or modify the battery.
- If the battery case has been damaged, do not touch exposed contents.
- There are no user-serviceable parts inside.

**Failure to follow these instructions may result in death or serious injury.**

### WARNING

#### ELECTRIC SHOCK AND FIRE HAZARD

Do not lay tools or other metal parts on top of the battery or across the terminals.

**Failure to follow these instructions may result in death or serious injury.**

### CAUTION

#### ELECTRIC SHOCK

- Do not touch the energized surfaces of any electrical component in the battery system.
- Before servicing the battery, follow all procedures to fully de-energize the battery system.
- Follow the "Safe Handling Procedures" below when working with the battery.

**Failure to follow these instructions may result in injury.**

## 1.4 Safe Handling Procedures

Before using the battery and any power electronics, read all instructions and cautionary markings on all components and appropriate sections of their manuals.

- Use personal protective equipment when working with batteries.
- Do not dispose of the battery in a fire.
- Promptly dispose or recycle used batteries following local regulations.
- Do not disassemble, open, crush, bend, deform, puncture, or shred.
- Do not modify, re-manufacture, or attempt to insert foreign objects into the battery, immerse or expose the battery to water, other liquids, fire, explosion, or other hazards. If the user suspects damage to the battery due to water, heat, or other reason, take it to a service center for inspection.

- Only use the battery for the system for which it is specified.
- Do not lift or carry the battery while in operation.
- When lifting a heavy battery, follow the appropriate standards.
- Only lift, move, or mount following local regulations.
- Take care when handling battery terminals and cabling.
- Only use the battery with a charging system that has been qualified for the system. The use of an unqualified battery or charger may present a risk of fire, explosion, leakage, or other hazards.
- Do not short circuit a battery or allow metallic conductive objects to contact battery terminals.
- Replace the battery only with another battery that has been qualified for the system. Using an unqualified battery may present a risk of fire, explosion, leakage, or other hazards.
- Avoid dropping the device or battery. If the device or battery is dropped, especially on a hard surface, and the user suspects damage, take it to a service center for inspection.

## 1.5 Personal Protective Equipment

When handling or working near a battery:

- Use Personal Protective Equipment, including clothing, glasses, insulated gloves, and boots.
- Do not wear rings, watches, bracelets, or necklaces.

## 2.0 Documentation

This document provides information about the integration and setup of LYNK II with Discover Lithium battery systems.

Before installation and configuration, consult the relevant product documentation, including Manuals, Application Notes, and Installation and Configuration Guides.

### Discover Energy Systems Systems Documentation

Visit <https://discoverlithium.com> for the most recent version of published documents, including Discover Lithium battery user manuals and application notes on using LYNK II with specific power conversion devices.

## 3.0 About LYNK II

### 3.1 Overview

LYNK II Communication Gateway unlocks the full potential of a Discover lithium battery by enabling the internal Battery Management System (BMS) to communicate closed-loop and in real-time State-of-Charge, voltage, temperature and status to compatible devices, such as solar or mobile inverter-chargers, on and off-board industrial chargers, displays, load centers, motor controls, PLCs and telematics. Serial CAN and CANopen Interface Guides are also available for developers.

### 3.2 Compatible Batteries and Devices

A battery or device must have a compatible port such as a LYNK Port or AEBus Port to communicate with a LYNK II device.

#### **LYNK Port**

- AES PROFESSIONAL batteries: DLP-GC2-12V, DLP-GC2-24V, DLP-GC2-36V, DLP-GC2-48V
- AES RACKMOUNT batteries: 48-48-5120, 48-48-5120-H

#### **AEBus Port**

- AES LiFePO<sub>4</sub> batteries: 44-24-2800, 44-48-3000, 42-48-6650, 14-36-3000, 14-48-3000

### 3.3 Compatible Communication Protocols

LYNK ACCESS software for 64-bit Windows 10 is required to configure LYNK devices for communication with compatible external devices such as inverters, chargers and motor controllers. Download the current version of LYNK ACCESS software from the Discover Energy Systems website to obtain the most up-to-date suite of available device configurations. An interface guide for Discover Generic Serial CAN is available from the Discover Energy Systems website.

<b>Available Communication Protocol Configurations (Partial List)</b>
Victron Energy - GX and VE.CAN Inverter-chargers, solar MPPT Chargers and network devices
Morningstar - GenStar MPPT Controller
Studer Innotec - XcomCan Inverter-Chargers and network devices
SPE - GREEN Series Industrial Chargers
Sol-Ark - Outdoor and Indoor (Legacy) Inverter-Chargers
SMA - Sunny Island Inverter-Chargers
Schneider Electric - Xanbus Inverter-chargers and MPPT Chargers and network devices
RV-C - Various brands of inverter-charger and monitoring devices
Discover Generic Serial CAN: <ul style="list-style-type: none"><li>• Morningstar</li></ul>
CANopen - See Discover CANopen Interface Guide

### 3.4 Firmware Revision

This User Manual is valid for firmware version 1.4.0.0 and above. Use LYNK ACCESS software to view the firmware version of your LYNK device.

## 4.0 Items Shipped in the Box

1	LYNK II device
1	USB cable (1 m, 3.28 ft) with a Type-B mini plug

## 5.0 Design and Features

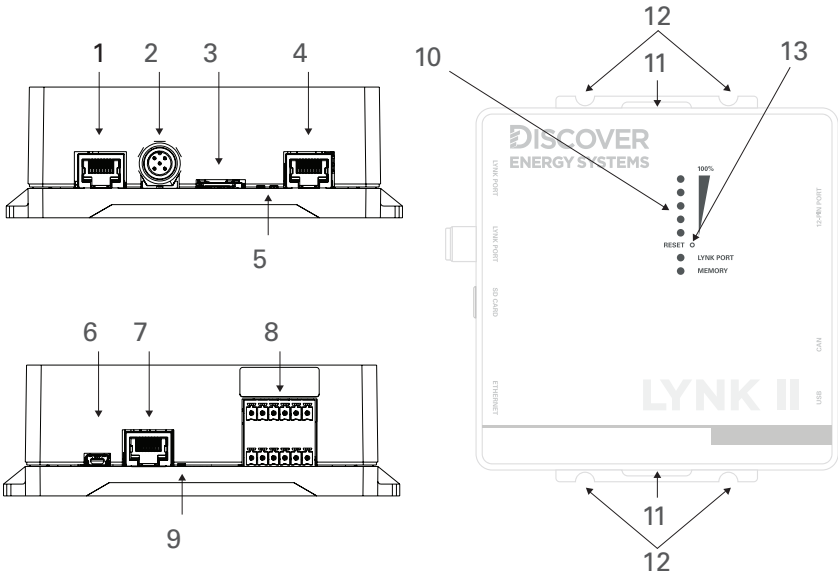

**Figure 1. Ports, Buttons, LEDs, and Mounting Hold Downs**

<b>1</b>	LYNK Port (AEBus)	RJ45 connection for LYNK AEBus Network communication input. Termination is configurable. (Terminated by Default)
<b>2</b>	LYNK Port	IEC M12 pin connector for LYNK Network communication input. Termination is configurable. (Terminated by Default)
<b>3</b>	Mini SD Card Slot	Used for extended battery data logging (128 GB) and updating battery and LYNK II device firmware.
<b>4</b>	Ethernet Port	RJ45 connection to the internet via an Ethernet cable.
<b>5</b>	Ethernet LEDs	Indicates Ethernet communication activity.
<b>6</b>	USB Mini Port	USB device port to connect with LYNK ACCESS software on Windows 10 devices.
<b>7</b>	CAN Out	RJ45 connection used for CAN communications. Termination is configurable.
<b>8</b>	Phoenix 12-pin Connector	Connections are used by the relays, CAN Out, and supply power.
<b>9</b>	CAN Out LED	Indicates communication activity.



10	Status LEDs	Five LEDs indicate the State-of-Charge level. LYNK Port LED indicates the status and activity on either the LYNK Port or LYNK AEBus Port. Memory LED indicates SD Card status.
11	Hold-Down Points	Hold-Down points for mounting the device with straps.
12	Mounting Slots	Slots for mounting the device with screws or bolts.
13	Reset Button	Pinhole button, press to reset LYNK II

## 5.1 Reset Button Operation

Press and hold duration	LYNK II Operation
5 seconds or less.	LYNK II will restart.

## 5.2 LED Indicators

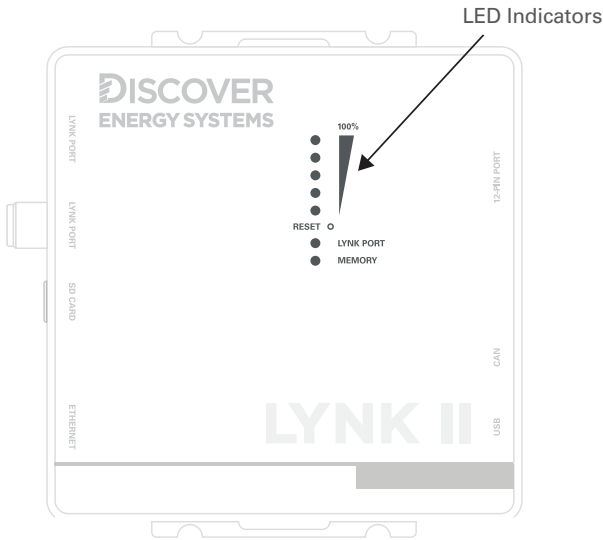
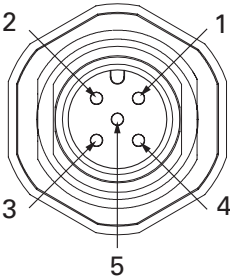

**Figure 2. LYNK II LED Indicators**

<b>State-of-Charge LEDs</b>	<b>Indication</b>
Segment - 5	Solid Green SOC is between 81-100%
Segment - 4	Solid Green SOC is between 61-80%
Segment - 3	Solid Green SOC is between 41-60%
Segment - 2	Solid Green SOC is between 21-40%
Segment - 1	Solid Green SOC is between 6-20%; Flashing Green SOC is 5% or below
Any LED Segment	Flashing once per second indicates the batteries are receiving a charge.
All LED Segments	Flashing two times per second indicates that one or more batteries are in protection mode.
Alternating Segment 1 through 5	This sequencing indicates that the LYNK II has power, but the batteries cannot communicate with LYNK II.

<b>Data LEDs</b>	<b>Indication</b>
LYNK Port LED	Flashes when a new battery is detected on one of the LYNK Ports. Solid when there is active communication on one of the LYNK Ports.
Memory LED	Off when no SD card is detected. They flash when data is transferred to or from the SD card. Solid when it is safe to remove the SD card.
Ethernet LEDs	Left LED - On when the connection is OK. The right LED - Blink when Tx/Rx Activity
CAN Out LED	This indicates that a CAN heartbeat message has been received in the proper protocol within the past 5 seconds.

### 5.3 LYNK Port Pin Assignment



**Figure 3. Pin Map M12 A-Code Circular Metric Connector.**

Pin	Description
1	Do Not Populate. Do not terminate to ground. Do not terminate to power. Do not terminate to CAN_L or CAN_H.
2	AEbus CAN L
3	AEbus CAN H
4	AEbus +12V
5	AEbus GND

### 5.4 Pin Assignments for Phoenix 12-pin Connector

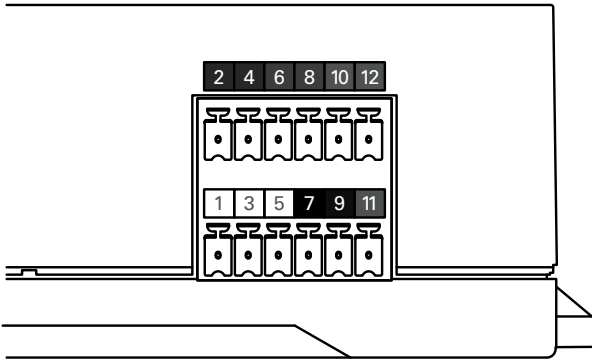

**Figure 4. Pin Assignments for Phoenix 12-pin Connector**

12-Pin Connector Layout					
2	4	6	8	10	12
RELAY 3 COM	RELAY 3 N/O	RELAY 2 N/O	RELAY 2 COM	RELAY 1 N/O	RELAY 1 COM
1	3	5	7	9	11
CAN HIGH	CAN LOW	CAN GND	POWER GND	POWER Vin (13-90V)	RELAY 1 N/C

## 5.5 Power Sources for LYNK II

LYNK II can utilize three power sources. All three power sources can be used alone or simultaneously. LYNK II will automatically use the highest priority source.

Priority	Source
1	13-90 VDC power supply input connected to pin 9 (Vin) and pin 7 (GND) of the 12-pin connector.
2	AEbus Port or LYNK Port of enabled batteries.
3	USB device (Relays will not function with USB as the only power supply)

### NOTE

AES LiFePO<sub>4</sub>, AES PROFESSIONAL, and AES RACKMOUNT batteries must be set to ON to supply power and communicate data with LYNK devices.

### AES PROFESSIONAL and AES RACKMOUNT Batteries

AES PROFESSIONAL and AES RACKMOUNT batteries supply power to LYNK II using the network cable connected to the LYNK Port.

### AES LiFePO<sub>4</sub> Batteries

AES LiFePO<sub>4</sub> batteries sold after Jan 1, 2020, supply power to LYNK II using the network cable connected to the AEbus Port.

### NOTE

AES LiFePO<sub>4</sub> batteries sold before Jan 1, 2020, do not supply power to LYNK II using the network cable connection. An external 13-90 VDC power source connected to the Phoenix 12-pin connector on LYNK II is **REQUIRED** for the AES LiFePO<sub>4</sub> batteries listed below.

- 42-48-6650 with a serial number before DET424820275xxxx
- 44-24-2800 with a serial number before DET442420225xxxx

## 6.0 CAN Hardware Termination and CAN Out Pin Configurations

Jumpers are used to configure termination for AEBus and CANbus, and the CAN Out pin assignments.

### NOTICE

#### HAZARD OF EQUIPMENT DAMAGE

Disconnect power and all connections to LYNK II before attempting to configure header jumpers.

**Failure to follow these instructions may result in damage to the equipment.**

### 6.1 Access to Configuration Header Boards and Jumpers

To access the configuration header boards and jumpers:

1. Disconnect power and all connected cables and wires from LYNK II.
2. Loosen the keeper nut on the threaded barrel LYNK Port.
3. Unscrew the four case screws using a Phillips screwdriver.
4. Carefully separate the top from the bottom casing - Ensure the keeper nut, LYNK Port barrel, and four case screws do not become lost or drop onto exposed battery cables or terminals. Save all items to reseal the unit later.
5. Place the jumpers on the correct headers noted below to configure CAN Termination and CAN Out pins.
6. Reinstall the LYNK Port barrel with keeper nut on the outside, mate the top and bottom casing together and replace the four screws.

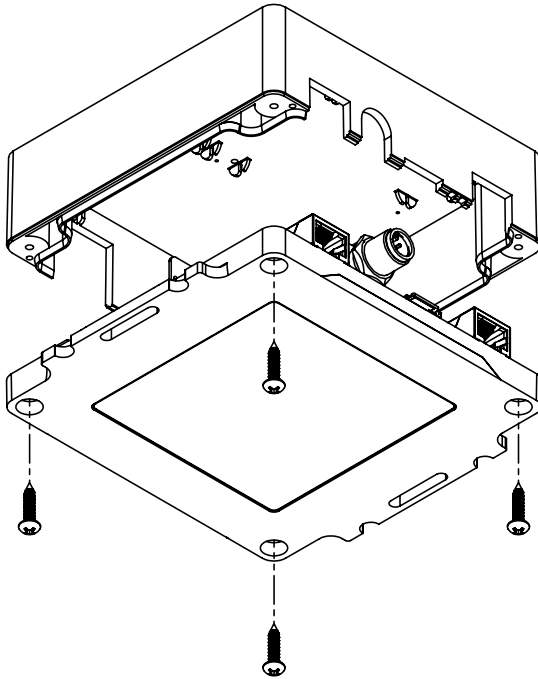

**Figure 5. LYNK II Case Construction**

## 6.2 CAN Termination

Jumpers are pre-positioned for the termination of AEBus and CANbus. Jumpers can be repositioned on the header board for different CAN Out RJ45 pin assignments.

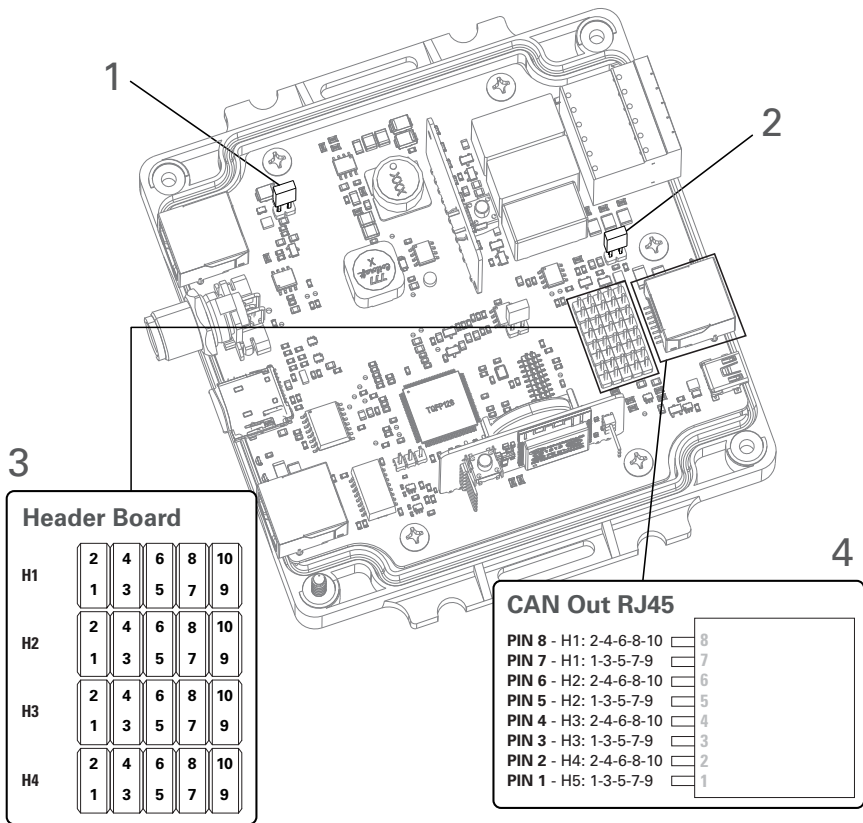

**Figure 6. CAN Termination**

1	AEBus Termination Header Board	A termination jumper is installed by default.
2	CAN Out Termination Header Board	A termination jumper is installed by default.
3	CAN Out RJ45 Configuration Header Board	Jumpers are used to customize the CAN Out RJ45 Port.
4	CAN Out RJ45 Pin Configuration	CAN Out RJ45 pins mapped to their Header Board positions.

**NOTE**

AEBus is terminated by default. Do not remove the AEBus termination jumper for LYNK II unless instructed to do so by Discover Energy Systems.

### 6.3 CAN Out - RJ45 Header Assignments

CAN signals (CAN H, CAN L, CAN GND) are assigned to any pin of the RJ-45 connector by adjusting the jumpers on the header board.

#### 6.3.1 Default pin assignments:

CAN Out	Header Jumper	RJ45 Pin
CAN L	H2 - 5-7	5
CAN H	H3 - 8-10	4
CAN GND	H4 - 2-4	2

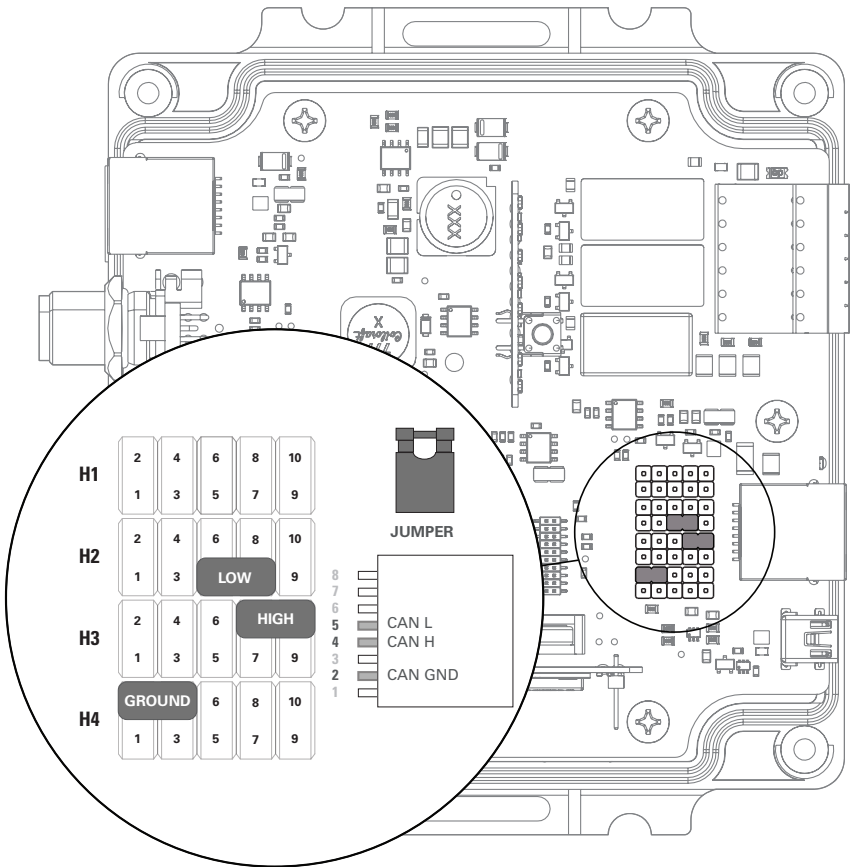

**Figure 7. Default pin assignments**



### 6.3.2 Common pin assignments:

**Victron Energy** - Color Control GX, Venus GX, VE.CAN Devices

**Studer Innotec** - Xcom-CAN Devices

CAN Out RJ45 Pin	Header Jumper	RJ45 Pin
CAN L	H1 - 6-8	8
CAN H	H1 - 7-9	7
CAN GND	H3 - 1-3	3

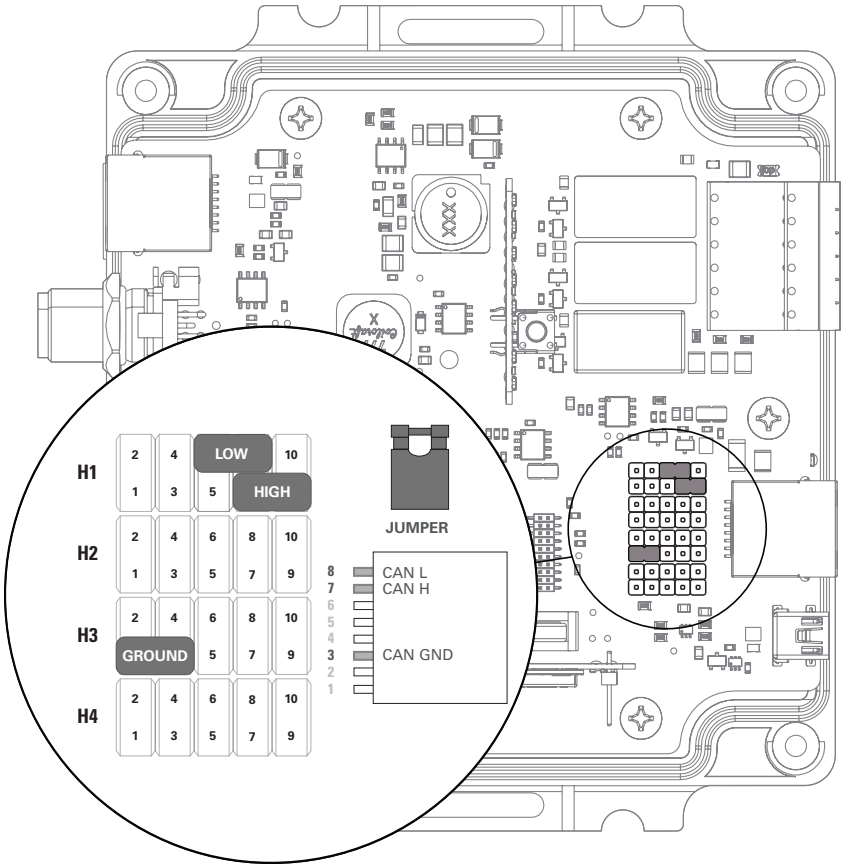

**Figure 8. Victron Energy and Studer Innotec pin assignments**

Schneider Electric - Xanbus Devices

CAN Out	Header Jumper	RJ45 Pin
CAN L	H3 - 6-8	4
CAN H	H2 - 7-9	5
CAN GND	n/a	n/a

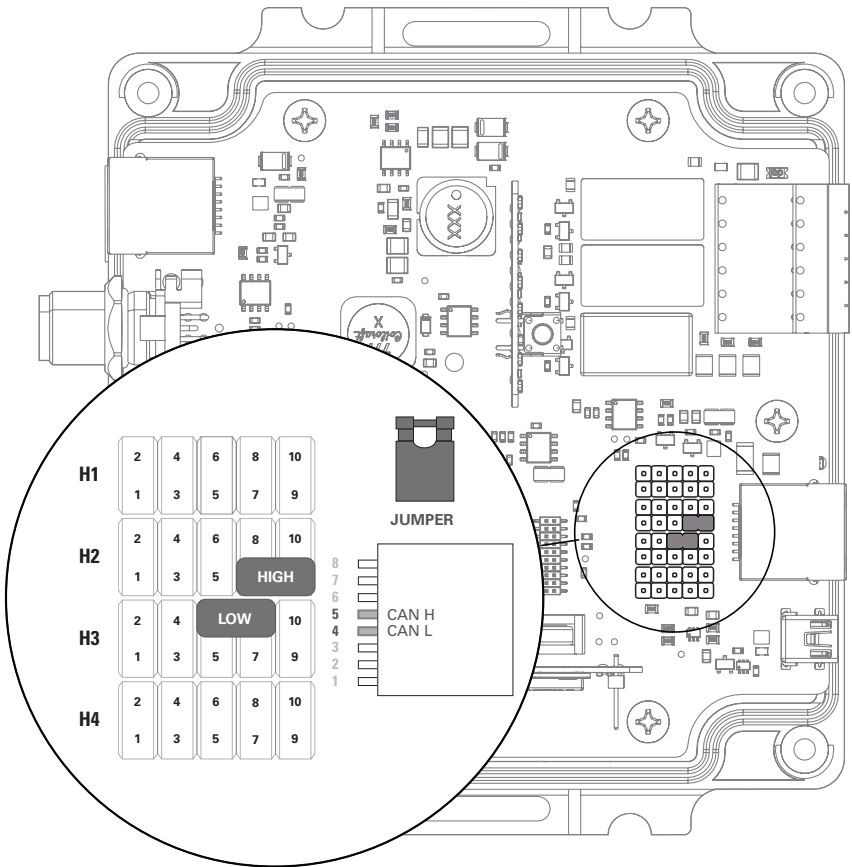

Figure 9. Schneider Electric pin assignments

**SMA** - Sunny Island 4.4M, 6.0H, 8.0H, 4548-US, 6048-US

**Sol-Ark** - 8K Hybrid Indoor (Legacy), 12K Hybrid Indoor (Legacy)

**Morningstar** - GenStar MPPT Controller

CAN Out	Header Jumper	RJ45 Pin
CAN L	H2 - 5-7	5
CAN H	H3 - 8-10	4
CAN GND	H4 - 2-4	2

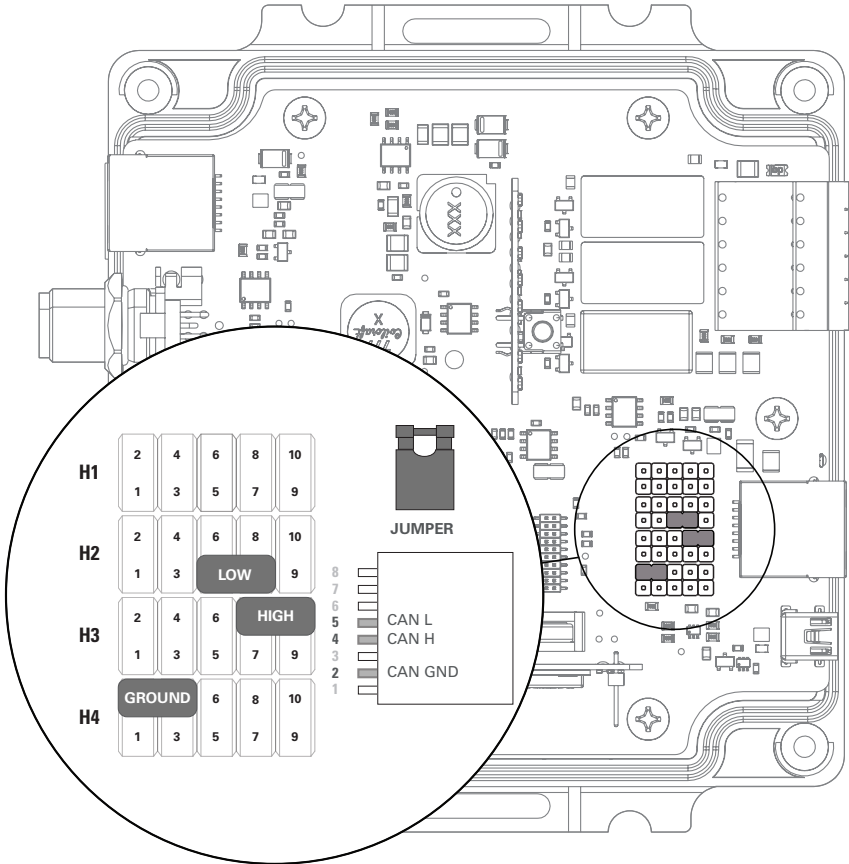

**Figure 10. SMA, Sol-Ark, and Morningstar pin assignments**

**Sol-Ark 5K-P / 8K-P / 12K-P / 15K-P (Outdoor)**

CAN Out	Header Jumper	RJ45 Pin
CAN L	H2 - 5-7	5
CAN H	H3 - 8-10	4
CAN GND	H2 - 2-4	6

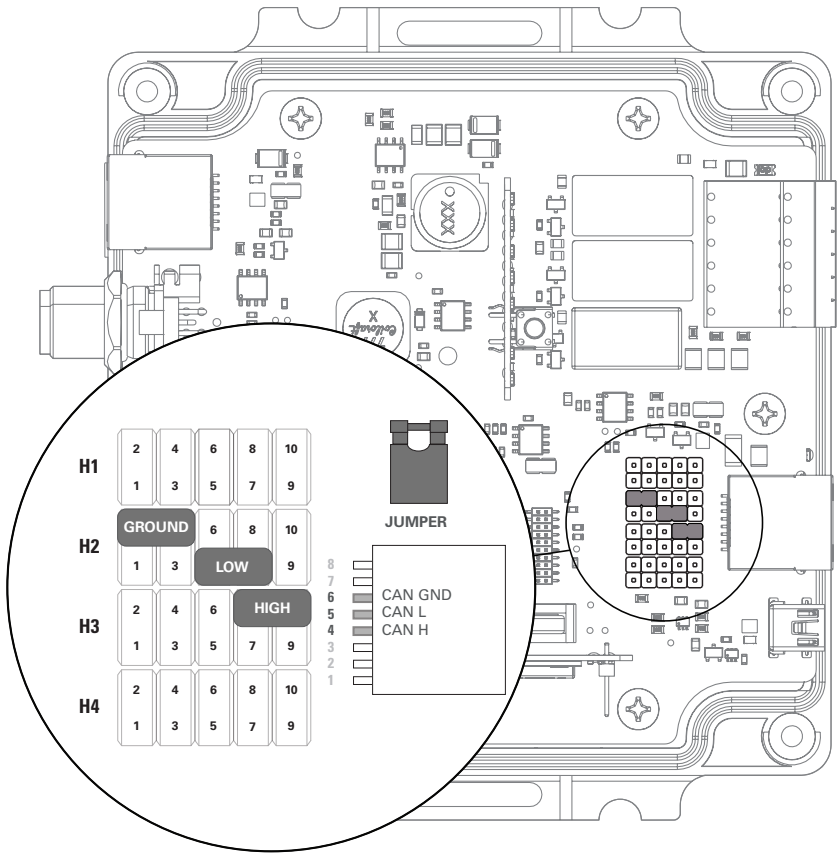

**Figure 11. Sol-Ark Outdoor CAN pin assignments**

## 7.0 Installation

Choose a clean, dry, easily accessible indoor location. All the communication ports on the LYNK II are accessible when mounted on a wall. Clearance of at least 100 mm (4 inches) from the connection points on the device is needed to allow for the bend radius of connected cables.

### 7.1 Mounting LYNK II

Screws or bolts can be threaded through the integrated Mounting Slots (Figure 5 - Figure 11) to affix LYNK II to a flat surface. Mounting screws, bolts and nuts are not included. Threading straps through the integrated Hold Down Points (Figure 5 - Figure 11) can be used to secure LYNK II to an object. Secure all cables to prevent them from working loose or becoming damaged.

### 7.2 7.2 Installing the External Power Source

LYNK II can utilize one of three power sources. LYNK II will automatically use the highest priority source if all three power sources are connected.

Connect LYNK II to one or more of the following:

- A 13-92 VDC power supply (or battery) is connected to the Phoenix connector pin 7 (GND) and pin 9 (Vin).
- The AEBus Port or LYNK Port of a Discover lithium battery.
- A USB device (Relays will not function with USB as the only power supply)

### 7.3 LYNK Network Communication Cables

#### CAUTION

##### HAZARD OF EQUIPMENT DAMAGE

- Do not connect a CAT5 cable from an AEBus Port or LYNK Port to a WAN or MODEM Ethernet port.
- Turn OFF all devices before connecting cables.
- Mixing the LYNK Network with other networks may result in equipment malfunction and damage.

**Failure to follow these instructions can damage equipment.**

## Networking Guidelines

- Separate data and power cables allow for separation between data and power cables. Avoid interference and data corruption caused by running network cables bundled with power cables.
- Allow for LYNK Network cable slack. Ensure that LYNK Network cables are slack and not in tension.
- Isolate the LYNK Network. Do not mix other networks with the LYNK Network.

### NOTE

The LYNK II Communication Gateway is internally terminated. A termination resistor is not required.

### LYNK (AEbus) Network Installation and Layout for AES LiFePO<sub>4</sub> batteries: 42-48-6650, 44-24-2800

Using a CAT5 or higher cable, insert one end into the LYNK Port (RJ45) on the LYNK II. Insert the other end of the CAT5 cable into the AEbus Port located on the AES LiFePO<sub>4</sub> battery. If there are multiple AES LiFePO<sub>4</sub> batteries, series network (daisy-chain) them together and insert the end of the CAT5 from LYNK II into the AEbus Y-Connector at the end of the network, as shown in [Figure 12](#). The LYNK II Communication Gateway is terminated internally. Termination at the opposite end of the LYNK (AEbus) network is also required.

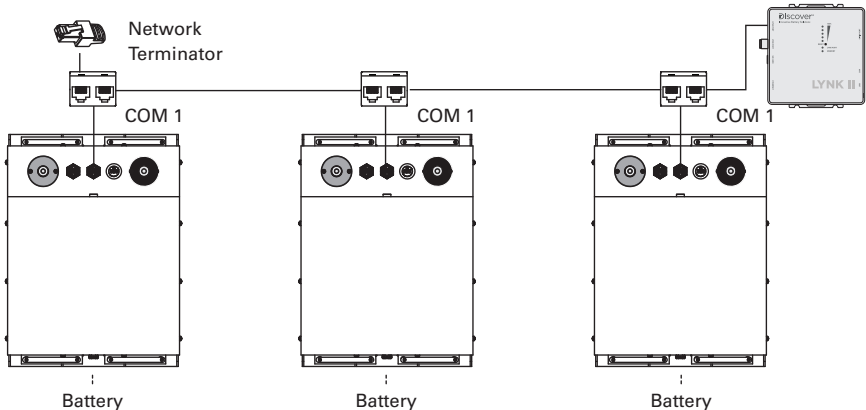

**Figure 12. LYNK Network Installation and layout**

## LYNK (AEBus) Network Installation and Layout for AES LiFePO<sub>4</sub> batteries: 14-36-3000, 14-48-3000, 44-48-3000

Using a CAT5 or higher cable, insert one end into the LYNK Port (RJ45) on the LYNK II. Insert the other end of the CAT5 cable into the AEBus Port located on the AES LiFePO<sub>4</sub> battery. If there are multiple AES LiFePO<sub>4</sub> batteries, network them together in a daisy chain. Connect the CAT5 cable from LYNK II to the AEBus Port of the battery at the end of the network, as shown in [Figure 13](#). The LYNK II Communication Gateway is terminated internally. Termination at the opposite end of the LYNK (AEBus) network is also required.

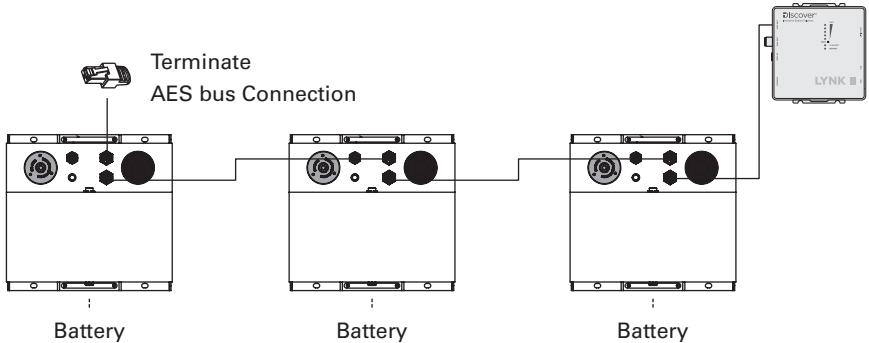
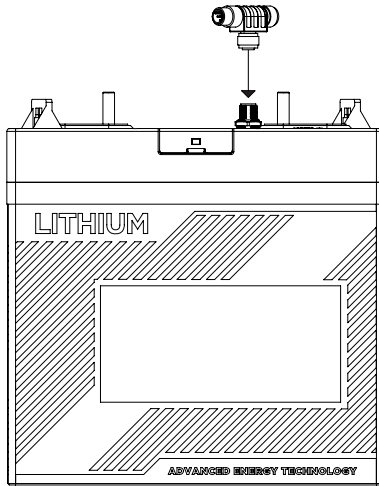

**Figure 13. LYNK Network Installation and layout for AES 3K models.**

## LYNK Network Installation and Layout for AES PROFESSIONAL batteries

1. Mount the devices according to their installation instructions before beginning network installations.
2. Attach the 950-0038 DLPT Connector to the LYNK Port on each battery ([Figure 14](#)). Ensure that the mating connectors are securely fastened.
3. Insert the male end of the cable into the female end of the 950-0038 DLPT Connector and vice versa.
4. Repeat until all batteries have been attached in a series network ([Figure 15](#)).
5. Attach one end of the series network to the LYNK Port on LYNK II. Termination of the other end is not required.

LYNK Network Cables Available for AES PROFESSIONAL Batteries	Part Number
DLP B2B-400 (COMM Cable 0.4 m)	950-0035
DLPTOL-7600 (COMM Cable 7.6 m)	950-0037
DLPTOL-1800 (COMM Cable 1.8 m)	950-0036
DLPT Connector (COMMT Connector) with DLP B2B-400 (COMM Cable 0.4 m)	950-0038
DLPT Connector (COMMT Connector)	950-0041



**Figure 14. Attaching DLPT Connector to LYNK Port**

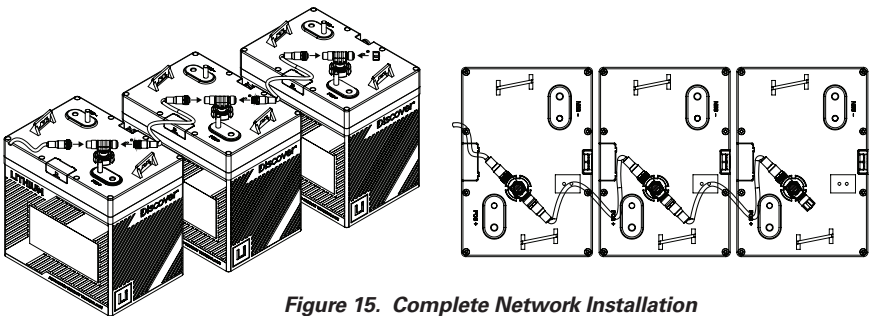

**Figure 15. Complete Network Installation**



## LYNK Network Installation and Layout for AES RACKMOUNT batteries

Using a CAT6 or higher cable, insert one end into the LYNK Port (RJ45) on the LYNK II. Insert the other end of the CAT6 cable into the LYNK Port located on the AES RACKMOUNT battery. If there are multiple AES RACKMOUNT batteries, insert CAT6 cables to daisy-chain the batteries together. No extra termination is required as the LYNK II Communication Gateway and AES RACKMOUNT batteries are terminated internally.

1. Mount the devices according to their installation instructions before beginning network installations.
2. Attach CAT6 or higher cables to the LYNK Port, from one battery to the next battery, until all the batteries are connected to form a series network (Figure 16).
3. At the end of the series network, attach a CAT6 or higher cable from the battery to the LYNK Port on LYNK II.

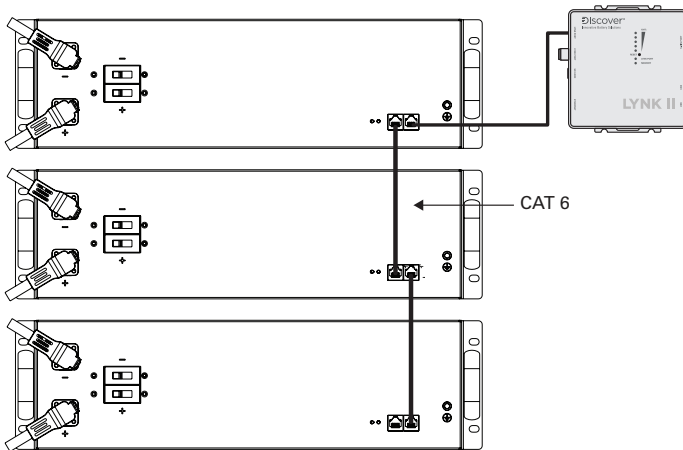

**Figure 16. LYNK Network Installation (AES RACKMOUNT)**

### 7.4 Verification of the LYNK Network

Verify the LYNK Network is complete using LYNK II.

- An illuminated LYNK Port LED confirms that communications are active for the LYNK Network.
- LYNK ACCESS software can be used via a computer to confirm the number of batteries in the LYNK Network.

## 8.0 Relay Hardware Installation

### NOTICE

#### HAZARD OF EQUIPMENT DAMAGE

Protect the relay contacts from overcurrent conditions with an external fuse.

**Failure to follow these instructions may cause damage to the equipment.**

See the 12-pin Connector Layout table and [Figure 17](#) below for the locations of pins on the Phoenix connector. Insert the connector wire into the correct pin hole. From the top of the connector pin hole, use a jeweller's flathead screwdriver to compress the screw and secure the wire. See section [13.0](#) for information on configuring the relays. The LYNK II relays are by default disabled.

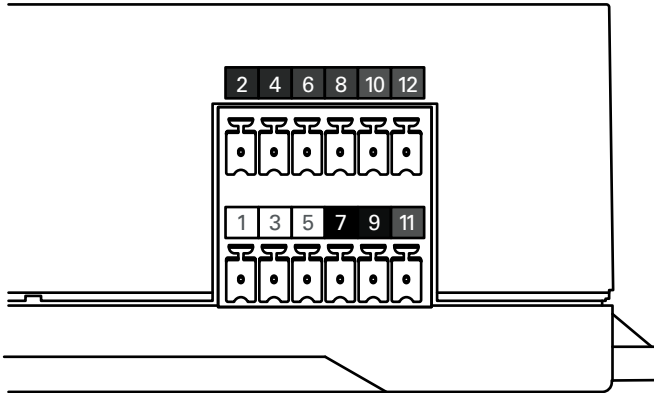

*Figure 17. Pin Assignments for Phoenix 12-pin Connector*

12-Pin Connector Layout					
2	4	6	8	10	12
RELAY 3 COM	RELAY 3 N/O	RELAY 2 N/O	RELAY 2 COM	RELAY 1 N/O	RELAY 1 COM
1	3	5	7	9	11
CAN HIGH	CAN LOW	CAN GND	POWER GND	POWER Vin (13-90V)	RELAY 1 N/C

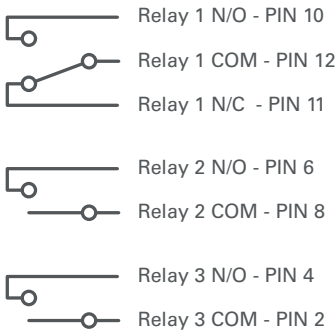

Relay	Output Characteristics
Relay 1	N/O 0-30 VDC, maximum 5 A N/O 0-250 VAC, maximum 5 A N/C 0-30 VDC, maximum 5 A N/C 0-250 VAC, maximum 3 A
Relay 2	0-30 VDC, maximum 5 A 0-250 VAC, maximum 5 A
Relay 3	0-30 VDC, maximum 5 A 0-250 VAC, maximum 5 A

## NOTE

The top and bottom Phoenix connectors can be removed by pulling them out of their socket. Reinstall in the same socket.

## 9.0 Ethernet Hardware Installation and Layout

### NOTICE

#### HAZARD OF EQUIPMENT DAMAGE

Do not plug a CANbus Terminator into the Ethernet Port of an LYNK II Gateway Device.

**Failure to follow these instructions may cause damage to the equipment.**

Ethernet is disabled and reserved for future functionality.

## 10.0 Connecting to LYNK ACCESS

LYNK ACCESS software for 64-bit Windows 10 is required to configure LYNK II devices for CAN communication with compatible external devices such as inverters, chargers and motor controllers.

Download the current version of LYNK ACCESS software from the Discover Energy Systems website to obtain the most up-to-date suite of available device configurations.

Using a USB cable with a Type-B mini plug, connect the 64-bit Windows 10 device running LYNK ACCESS software to the USB port on LYNK II.

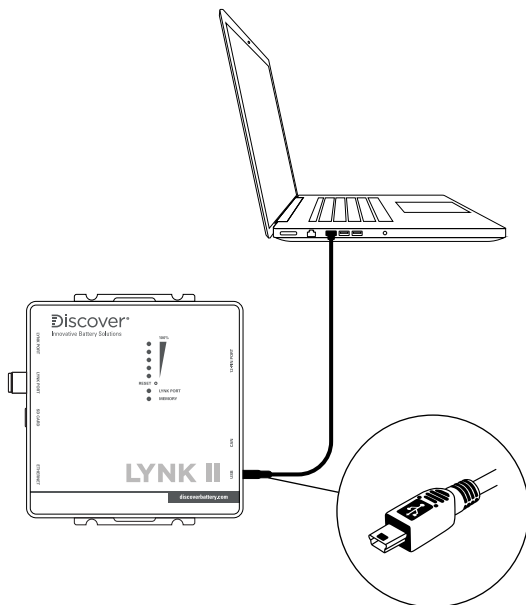
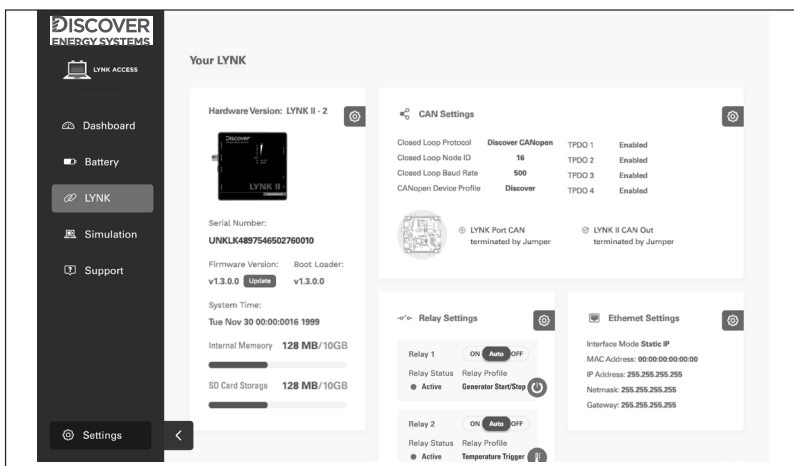

**Figure 18. LYNK II USB Type-B Mini connection.**

## NOTE

A powered USB hub may be required as a source of power to operate LYNK II.

Start the LYNK ACCESS software program. LYNK II configurations and settings are found by selecting the LYNK tab.



**Figure 19. LYNK II configuration and settings screen.**

## 11.0 Configuring the CAN Communication with LYNK ACCESS

Connect the LYNK II to a PC with LYNK ACCESS software installed. Ensure that you only have one LYNK device connected to the Computer.

Start the LYNK ACCESS software and select the LYNK tab. Select the blue gear icon in the upper right area of the CAN Settings tile.

Select one of the pre-configured Closed-Loop Protocols to complete the configuration. Click SAVE to confirm the configuration.

Refer to the appropriate application note for instructions on setting the external device to communicate correctly with LYNK II. The Discover Energy Systems website has up-to-date application notes for various external devices.

### NOTICE

#### HAZARD OF EQUIPMENT DAMAGE

Saving configuration changes using LYNK ACCESS will automatically restart LYNK II and cause communications with other devices to be interrupted.

**Failure to follow these instructions may cause damage to the equipment.**

## 12.0 Configuring Ethernet Settings with LYNK ACCESS

Reserved for future functionality.

## 13.0 Configuring Relays with LYNK ACCESS

Configuration of the LYNK II relays should only be done by qualified personnel.

Start the LYNK ACCESS software and select the LYNK tab. Select the blue gear icon in the upper right area of the Relay Settings tile.

Select the relay to be configured. Select one of the pre-configured relay modes and follow any on-screen prompts to finish the configuration. Click SAVE to confirm the configuration.

The LYNK II relays can be forced ON or OFF from within LYNK ACCESS to confirm the operation. Use LYNK ACCESS to clear the relay state.

## NOTICE

### HAZARD OF UNEXPECTED EQUIPMENT OPERATION AND DAMAGE

Unexpected equipment activity may occur while programming the relays. Disconnect all devices by removing the Phoenix connector from LYNK II. Replace the Phoenix connector when programming is completed.

**Failure to follow these instructions may cause unexpected equipment operation and damage to the equipment.**

## NOTE

- If the relay triggers, then Max RunTime expires, and the trigger value is still below the threshold, the relay will be retriggered.
- If daylight savings changes affect your area, review and reset all time-based triggers at the changeover date.
- By default, the relays are disabled.
- Saving the relay settings will automatically restart LYNK II.
- A relay that has been forced ON or OFF will remain in the selected state even after a power reset. Use LYNK ACCESS to clear a relay.

### 13.1 Relay Configuration - Triggers and Features

Trigger Source	Selects the desired source that activates the relay: SOC, Low Cell Voltage, High Cell Voltage, Average Cell Voltage, Highest Internal Temperature, Lowest Internal Temperature and System Current.
Trigger OnThreshold	Sets the voltage, temperature, SOC, or current threshold that activates the relay.
Trigger On Delay	Sets a delay period between when the trigger source reaches the activation threshold and when the relay is activated.
Trigger OffThreshold	Sets the voltage, temperature, SOC, or current threshold that deactivates the relay.
Trigger Off Delay	Sets a delay period between when the trigger source reaches the activation threshold and when the relay is deactivated.
Rising Edge Trigger	Sets a threshold value that is activated when the Trigger Source is increasing.

Falling Edge Trigger	Sets a threshold value that is activated when the Trigger Source is decreasing.
Max Run Time	Sets the maximum time that a relay can remain activated after being triggered. Independent of Quiet Time or Exercise Time mode.
Quiet Time (Scheduled Off)	Only available with Generator start/stop mode: The relay will not activate ON during the programmed period. The feature is inactive when the relay has been Forced ON or Forced OFF.
Exercise Time (Scheduled On)	Only available with Generator start/stop mode: The relay will activate ON and OFF based on the programmed period, regardless of other values and thresholds. The feature is not active when the relay is in Forced On or Forced Off.

## 13.2 Relay Configuration - Trigger Sources and Value Ranges

Disabled	The relay is not configured.
State of Charge	Activate the relay based on the State of Charge of the Discover Lithium battery system. Valid trigger threshold: 1% - 99%
Low Cell Voltage	Activate the relay based on the lowest cell voltage in the Discover Lithium battery system. This trigger source is commonly used for load shedding as the battery system reaches low voltage. Valid trigger threshold: 2000 mV - 3650 mV
Average Cell Voltage	Activate the relay based on the average cell voltage of the Discover Lithium battery system. Valid trigger threshold: 2000 mV - 3650 mV
High Cell Voltage	Activate the relay based on the highest cell voltage in the Discover Lithium battery system. Valid trigger threshold: 2000 mV - 3650 mV
Lowest Internal Cell Temperature	Activate the relay based on the lowest internal cell temperature in the Discover Lithium battery system. This trigger source is commonly used for activating heating HVAC systems. Valid trigger threshold: -20 to 55 °C (-4 to 131 °F)

Highest Internal Cell Temperature	Activate the relay based on the highest internal cell temperature in the Discover Lithium battery system. This trigger source is commonly used for activating cooling HVAC systems. Valid trigger threshold: -20 to 55 °C (-4 to 131 °F)
Battery DC Current	Activate the relay based on the aggregate DC Current of the Discover Lithium battery system. Valid trigger threshold: -5000 A to 5000 A

### 13.3 Relay Configuration - Operation States

Once configured, the relay will operate in 1 of 3 states: Auto, Forced ON and Forced OFF.

Auto:	Automatically activates and deactivates the relay-based the user-configured logic.
Forced ON	Immediately activates and holds the relay in the activated state. This state is not cleared during a power reset.
Forced OFF	Immediately deactivates and holds the relay in the inactivated state. This state not is cleared during a power reset.

#### **NOTE**

A relay that has been forced ON or OFF will remain in the selected state even after a power reset. Use LYNK ACCESS to clear a relay.

## 14.0 Updating LYNK II Firmware with LYNK ACCESS

Open LYNK ACCESS and select the LYNK Tab. Select the Firmware Version update button and follow the on-screen prompts to complete the update process. Click SAVE to confirm the configuration.



## 15.0 Specifications

DEVICE	LYNK II COMMUNICATION GATEWAY
Part Number	950-0025
L x W x H	120 x 135 x 44 mm (4.7 x 5.4 x 1.7 in)
Weight	0.3 kg (0.7 lb)
IP Rating	IP20 (Indoor Use Only)
Temperature Operating:	-20 to 50°C (-4 to 122°F)
Temperature Storage:	-40 to 85°C (-40 to 185°F)
Humidity Operating	< 95%, Non-condensing
Humidity Storage	< 95%, Non-condensing
Mounting	Built-in Surface Mount Bracket
Marking	CE

