

LYNK II

(950-0025)

LYNK II RELAY GUIDE REFERENCE MANUAL

READ AND SAVE THESE INSTRUCTIONS

INTRODUCTION 3

1. AUDIENCE, MESSAGES, WARNINGS, GENERAL SAFETY, PERSONAL PROTECTIVE EQUIPMENT 3

1.1 Audience3

1.2 Warning, Caution, Notice, and Note Messages3

1.3 General Warnings4

1.4 Safe Handling Procedures4

1.5 Personal Protective Equipment5

2. DOCUMENTATION 5

3. OVERVIEW 6

3.1 LYNK II Phoenix Connector6

4. LYNK ACCESS 7

4.1 4.1 Programmable Relays7

4.2 LYNK ACCESS: Programming the Relays8

5. EXAMPLE RELAY CONFIGURATIONS 10

5.1 Simple Load Control Example (SOC Trigger) 10

5.2 Two-Wire Start Example (Generator Start/Stop) 11

5.3 Utility Loss Control Example (Generator Start/Stop) 12

5.4 Battery Heating Control Example (CellTemp Min Trigger) 13

5.5 Load Control Example (SOC Trigger) 14

5.6 Well Pump Control Example (SOC Trigger) 15

5.7 Diversion of Excess Power Example (Cell Voltage Max Trigger) 16

Introduction

This Relay Guide provides information about using the Relays on the LYNK II Communication Gateway to control the operation of peripheral equipment. The LYNK II is configured with three relays you can use to control equipment such as a generator, heater, and air conditioner. The LYNK ACCESS software programs the condition that switches the relay to turn the equipment ON or OFF.

1. AUDIENCE, MESSAGES, WARNINGS, GENERAL SAFETY, PERSONAL PROTECTIVE EQUIPMENT

1.1 Audience

Configuration, installation, service, and operating tasks should only be performed by qualified personnel in consultation with local authorities having jurisdiction and authorized dealers. Qualified personnel should have training, knowledge, and experience in the:

- Installation of electrical equipment
- Application of applicable installation codes
- Analysis and reduction of the hazards involved in performing electrical work
- Installation and configuration of batteries
- Installation and configuration of systems activated by relays.

1.2 Warning, Caution, Notice, and Note Messages

Messages in this manual are formatted according to this structure.

WARNING

Important information regarding hazardous conditions that may result in personal injury or death.

CAUTION

Important information regarding hazardous conditions that may result in personal injury.

NOTICE

Important information regarding conditions that may damage the equipment but not result in personal injury.

NOTE

Ad hoc information concerning important procedures and features unrelated to personal injury or equipment damage.

1.3 General Warnings

WARNING

ELECTRIC SHOCK AND FIRE HAZARD

- The LYNK II must only be installed as specified.
- Do not disassemble or modify a battery.
- If the battery case has been damaged, do not touch exposed contents.
- There are no user-serviceable parts inside the battery.

Failure to follow these instructions may result in death or serious injury.

CAUTION

ELECTRIC SHOCK HAZARD

- Do not touch the energized surfaces of any electrical component in the LYNK II system.
- Do not handle if the LYNK II is live and powered using pins 7 and 9 of the Phoenix terminal connector.
- Before servicing a LYNK II system, follow all procedures to fully de-energize the system.
- Follow the “Safe Handling Procedures” below when working with the battery and the LYNK II.

Failure to follow these instructions may result in injury.

1.4 Safe Handling Procedures

Before using the LYNK II, battery, and any power electronics, read all instructions and cautionary markings on all components and appropriate sections of their manuals.

- Use personal protective equipment when working with batteries and the LYNK II.
- Do not dispose of the battery or LYNK II in a fire.
- Promptly dispose of or recycle the LYNK II and used batteries following local regulations.
- Do not disassemble, open, crush, bend, deform, puncture, or shred.
- Do not modify, re-manufacture, or attempt to insert foreign objects into the battery, immerse or expose the battery to water or other liquids, fire, explosion, or other hazards. If the user suspects damage to the battery due to water, heat, or other reason, take it to a service center for inspection.
- Only use the LYNK II and battery for the system for which it is specified.
- Do not lift or carry the LYNK II or battery while in operation.
- Take care when handling LYNK II wiring, battery terminals, and cabling.
- Only use the LYNK II and battery with a charging system that meets specifications. Using a battery or charger that does not meet specifications may present a risk of fire, explosion, leakage, or other hazards.

- Do not short-circuit the LYNK II or battery, or allow metallic conductive objects to contact power terminals.
- Use the LYNK II with Discover Energy Systems batteries only, which are compatible with the LYNK II. Using an incompatible battery may present a risk of fire, explosion, leakage, or other hazards.
- Do not drop the LYNK II or battery. If the LYNK II or battery is dropped, especially on a hard surface, and the user suspects damage, take it to a service center for inspection.

1.5 Personal Protective Equipment

When handling or working near a LYNK II that is live and powered using pins 7 and 9 of the Phoenix terminal connector:

- Use Personal Protective Equipment, including clothing, glasses, insulated gloves, and boots.
- Do not wear rings, watches, bracelets, or necklaces.

2. DOCUMENTATION

This Technical Guide provides information about configuring the Relays on the LYNK II Communication Gateway.

Before installation and configuration, consult the relevant product documentation, including Manuals, Application Notes, and Installation and Configuration Guides.

Discover Energy Systems Documentation

Visit <http://discoverlithium.com> for the most recent version of published documents, including Discover Energy Systems Lithium battery user manuals and the LYNK II Installation and Operation Manual (805-0033), LYNK ACCESS (software) and LYNK II firmware.

NOTICE
Updating the LYNK II firmware may not work if you are not using the latest version of the LYNK ACCESS software. To resolve, first update LYNK ACCESS to the latest available version, then update the firmware.

3. OVERVIEW

This manual provides general settings and is not a comprehensive guide to the programming and configuration of a specific installation. An installation may have unique conditions or use cases requiring value modification or adaptations. Installers must be capable of reviewing and adapting to the specifics of an installation and its specific use case and optimizing settings where needed.

The key steps required to install and configure the LYNK II Communication Gateway with compatible Discover Energy Systems Lithium batteries and power conversion equipment are as follows:

- Review and confirm equipment compatibility and correct sizing.
- Mount the LYNK II, and connect the Discover Energy Systems battery communication network to either the LYNK Port or AEBus Port.
- Match and connect the LYNK II CAN out pins to the CAN pins of the power conversion communication network.
- Terminate all networks correctly.
- Set up the open-loop configuration parameters (fail-safe voltage set points) on the power conversion equipment in the unlikely event that closed-loop communication fails.
- Set the LYNK II using LYNK ACCESS software to the correct protocol to enable closed-loop communication between the Discover Energy Systems batteries and the power conversion equipment.
- Set up the closed-loop configuration parameters on the power conversion equipment.
 - LYNK II Sol-Ark User Manual
 - LYNK II Schneider XW Pro With InsightHome (Xanbus)
 - LYNK II Victron (Solar) Manual
 - LYNK II SMA Sunny Island User Manual
- Set up user preferences and enable the use case using the power conversion control system.

3.1 LYNK II Phoenix Connector

The pins on the LYNK II Communication Gateway's Phoenix connector are shown below.

12-Pin Connector Layout					
2	4	6	8	10	12
RELAY 3 GND	RELAY 3 N/O	RELAY 2 N/O	RELAY 2 GND	RELAY 1 N/O	RELAY 1 GND
1	3	5	7	9	11
CAN H	CAN L	CAN GND	POWER GND	POWER V in (13-90 V)	RELAY 1 N/C

There are three programmable relays on pins 2, 4 (Relay 3), 6, 8 (Relay 2), 10, 11, and 12 (Relay 1). The relays allow 0 to 30 VDC at a maximum of 5 A to pass through, or 0 to 250 VAC at a maximum of 5 A.

The relay terminals accept a maximum wire gauge of 13 AWG. M2 screws (head size 2 mm [0.08 in]) clamp the wires in the terminals and accept a maximum torque of 0.2 Nm (0.15 ft-lb).

4. LYNK ACCESS

The LYNK ACCESS PC software enables you to configure Discover Energy Systems batteries and view the values of battery parameters.

NOTE

The LYNK ACCESS software runs on the Windows operating system only.

Using LYNK ACCESS:

- Configure CANbus communication protocols on the LYNK II communication gateway.
- View the state of charge, battery current, voltage, and temperature of Discover Energy Systems Lithium battery systems, so installers and service technicians can troubleshoot the system by viewing the battery data.
- Configure LYNK II relays.

Refer to the 805-0033 LYNK II Installation and Operation Manual for information about configuring the closed-loop protocol and for troubleshooting batteries. The following discusses working with the LYNK II relays.

4.1 4.1 Programmable Relays

Among the three relays on the LYNK II, relays 2 and 3 operate as normally open (NO) relays. Relay 1 is configured with both normally open (NO) and normally closed (NC) relays.

• Relay 1

Pin 10 is Normally Open. When Relay 1 is activated, pin 10 is closed and allows voltage to pass through. Pin 12 is the common leg of the relay.

Pin 11 is Normally Closed. When Relay 1 is activated, pin 11 is opened and does not allow voltage to pass. Pin 11 allows voltage to pass through when Relay 1 is deactivated. Pin 12 is the common leg of the relay.

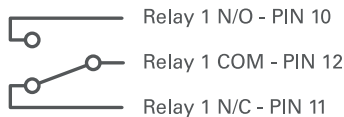

• Relay 2

Pin 6 is Normally Open. When Relay 2 is activated, the relay is closed and allows voltage to pass through. Pin 8 is the common leg of the relay.

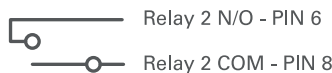

• Relay 3

Pin 4 is Normally Open. When Relay 3 is activated, the relay is closed and allows voltage to pass through. Pin 2 is the common leg of the relay.

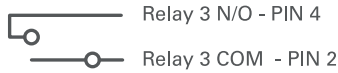

For more information about the LYNK II relays, refer to the LYNK II Installation and Operation Manual (805-0033).

4.2 LYNK ACCESS: Programming the Relays

1. Connect the USB Type-A/mini-B cable from the LYNK II to the computer with the LYNK ACCESS application installed.

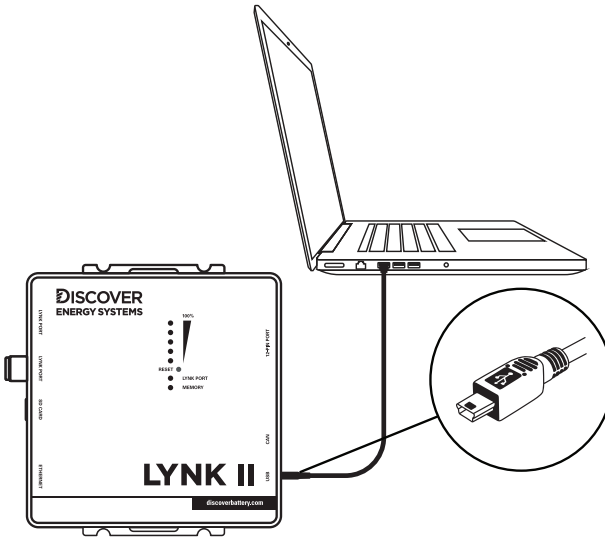
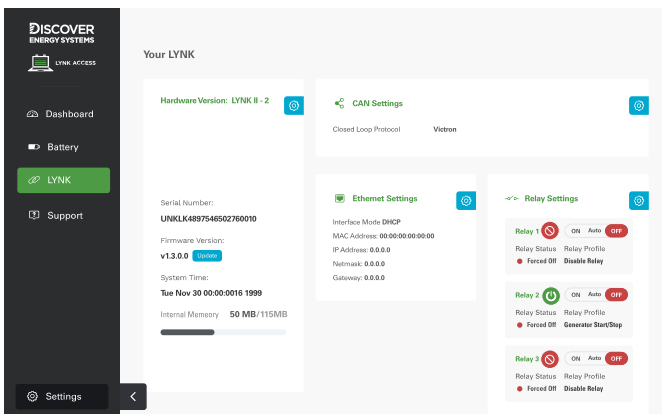
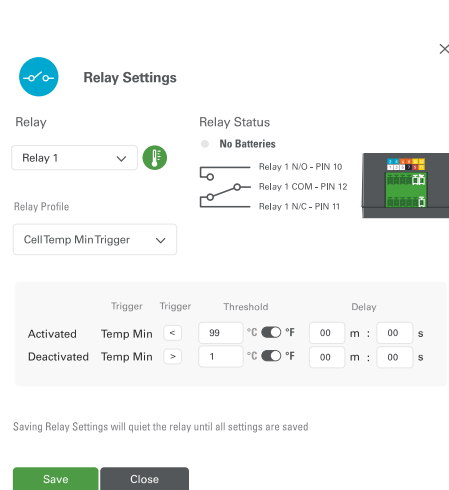
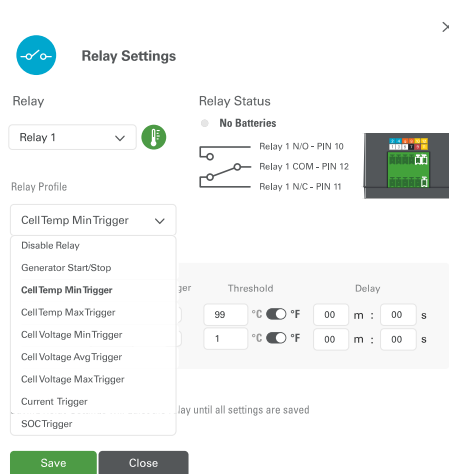
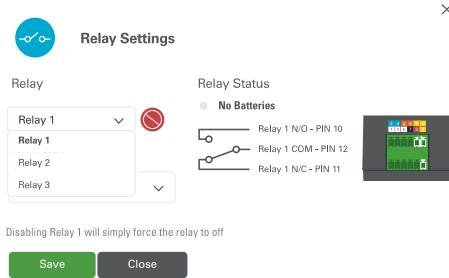

Figure 1. LYNK II USB mini-B connection

2. Start up LYNK ACCESS.



- In the Navigator pane, click the LYNK icon to view the LYNK II information.
- In the Relay Settings frame, click the gear icon.
- In the Relay Settings, select the Relay, the Relay Profile, and the relay's Activated and Deactivated parameters.



6. Click Save to save changes to the settings.

For more information on programming relays, refer to the LYNK II Installation and Operation Manual (805-0033).

NOTE

If you encounter difficulties getting the LYNK ACCESS software to recognize the LYNK II, try reversing steps 1 and 2 (start LYNK ACCESS then connect the USB cable) and wait up to a minute.

5. EXAMPLE RELAY CONFIGURATIONS

The following example configurations show how to use the LYNK II relays and battery information to control operations. The example configurations are simplified and should be wired to follow all regulations as specified by the Local Authority Having Jurisdiction. As the circumstances surrounding your particular installation may require different settings, program and wire accordingly.

5.1 Simple Load Control Example (SOC Trigger)

Allow specified loads to operate without over-discharging the battery.

Activated: 5 seconds after the battery SOC increases above 60%

Deactivated: 5 seconds after the battery SOC drops below 25%

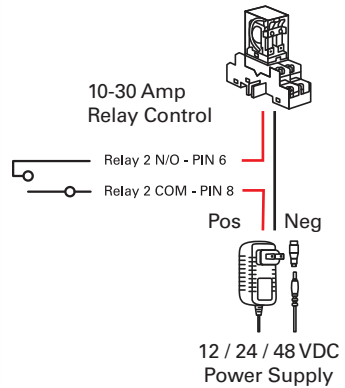
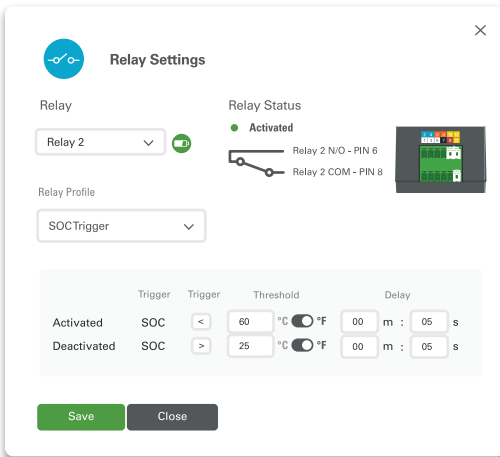

When the battery SOC rises above 60% SOC, after 5 seconds, the Normally Open switch (pin 6) on Relay 2 is closed (activated) and allows power to flow to the relay control and power the load. When the battery drops below 25% SOC, after 5 seconds, the switch (pin 6) is opened (deactivated) and cuts the power flow.

5.2 Two-Wire Start Example (Generator Start/Stop)

Turn ON the generator when the battery SOC drops below 10%.

Activated: 1 minute after the battery SOC drops below 10%

Deactivated: 1 minute after the battery SOC rises above 50%

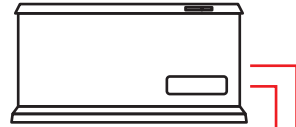
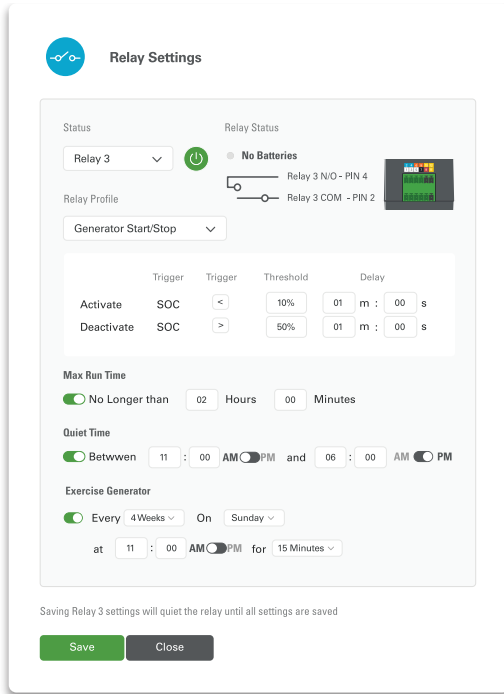

To Wire Harness for two Wire Start

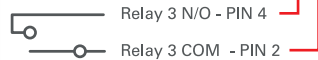

Based on the Activated settings, a minute after the battery SOC drops below 10%, pin 4 is closed (activated) and allows power flow to turn ON the generator.

Stopping the generator is based on the Deactivated settings. The switch (pin 4) is opened (deactivated), which stops the flow of power and turns OFF the generator, a minute after the battery SOC rises above 50%, after the generator runs for 2 hours, or when the system enters QuietTime.

The generator is also turned ON every 4th Sunday at 3 PM for 15 minutes.

NOTE

There are triggers other than Generator Start/Stop that can be used to start/stop a generator, but they do not have the Max Run Time, Quiet Time, and Exercise Generator controls.

5.3 Utility Loss Control Example (Generator Start/Stop)

Utility loss generator power the terminals of the inverter.

Activated: 5 seconds after the battery SOC drops below 10%

Deactivated: 5 seconds after the battery SOC rises above 70%

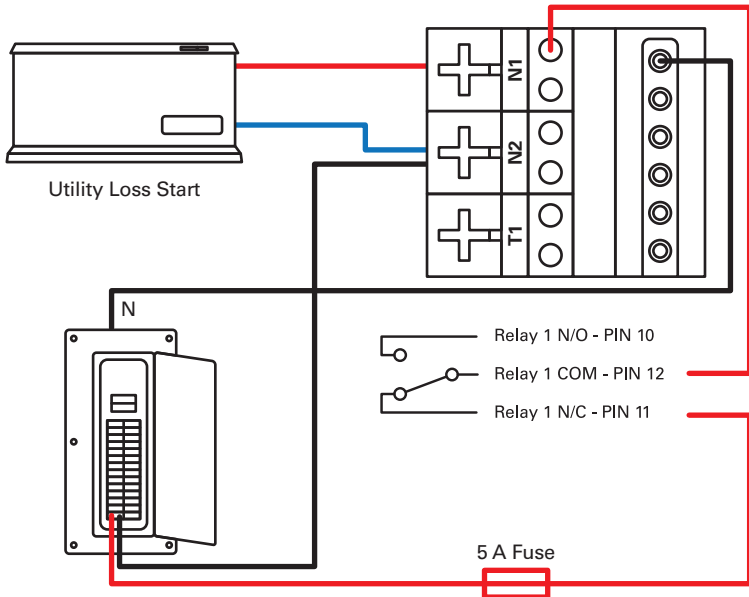
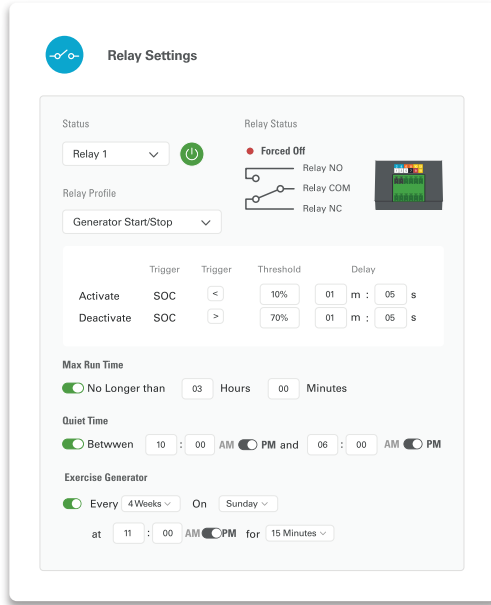

When there is a power failure, the grid goes offline and the batteries are used to power loads and the utility loss terminals on the generator.

When the battery SOC drops below 10%, after a 5-second delay, pin 10 is closed (activated) and starts the generator to recharge the batteries. Once the battery SOC is greater than 70%, after a 5-second pause, pin 10 is opened (deactivated), and the generator is turned off.

5.4 Battery Heating Control Example (Cell Temp Min Trigger)

Low battery cell temperature activates the DC heating mat.

Activated: 5 minutes after the battery CellTemperature drops below 2 °C (36 °F).

Deactivated: 1 minute after the battery CellTemperature rises above 8 °C (47 °F).

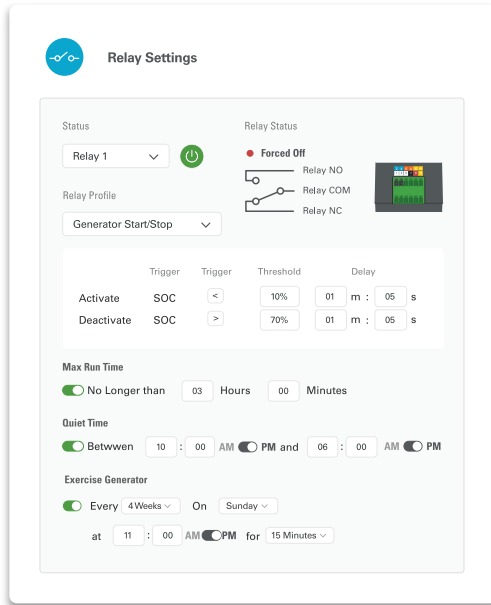

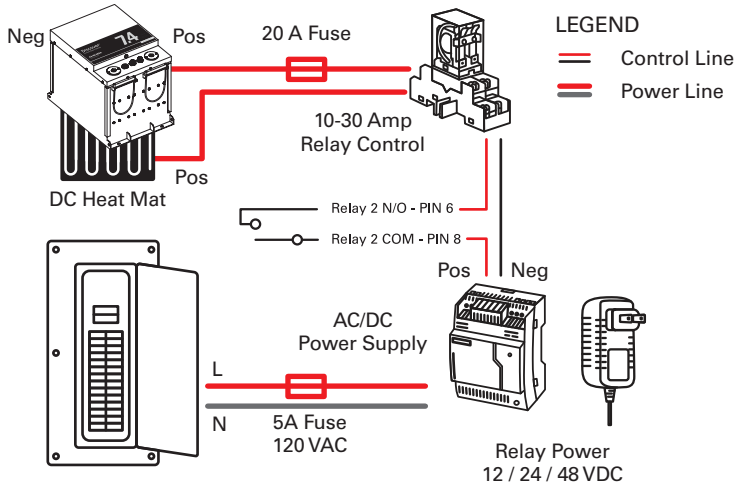

When the temperature drops below 2 °C (36 °F), after 5 minutes, Relay 2's Normally Open switch (pin 6) is closed (activated) and enables power flow to the DC heat mat to warm up the battery. The switch (pin 6) is opened (deactivated) 1 minute after the battery cell temperature rises above 8 °C (47 °F).

5.5 Load Control Example (SOC Trigger)

Relays are useful for controlling the power on loads you want available without over-discharging the battery. This is especially important on loads that require huge amounts of energy.

In this example, the batteries are powering three large loads: an EV charger, air conditioner, and oven.

Activated: 5 minutes after the battery SOC rises above 60%

Deactivated: 1 minute after the battery SOC drops below 25%

Relay: Relay 1

Relay Profile: SOCTrigger

Relay Status: Forced Off

Relay 1 N/O - PIN 10
Relay 1 COM - PIN 12
Relay 1 N/C - PIN 11



	Trigger	Trigger	Threshold	Delay
Activated	SOC	<	60 °C <input type="checkbox"/> °F	05 m : 05 s
Deactivated	SOC	>	25 °C <input type="checkbox"/> °F	01 m : 05 s

Relay: Relay 2

Relay Profile: SOCTrigger

Relay Status: Forced Off

Relay 2 N/O - PIN 6
Relay 2 COM - PIN 8



	Trigger	Trigger	Threshold	Delay
Activated	SOC	<	60 °C <input type="checkbox"/> °F	00 m : 05 s
Deactivated	SOC	>	25 °C <input type="checkbox"/> °F	00 m : 05 s

Relay: Relay 3

Relay Profile: SOCTrigger

Relay Status: Forced Off

Relay 3 N/O - PIN 4
Relay 3 COM - PIN 2



	Trigger	Trigger	Threshold	Delay
Activated	SOC	<	60 °C <input type="checkbox"/> °F	00 m : 05 s
Deactivated	SOC	>	25 °C <input type="checkbox"/> °F	00 m : 05 s

Relays 1, 2, and 3 are used to control when batteries are used to power a load. The relays are closed (activated) 5 seconds after the battery SOC rises above 60%, which closes the circuit to allow energy flow and can be used to power the associated load. After 5 seconds after the battery SOC drops below 25%, the relays are opened (deactivated) to stop the flow of power from the batteries, which protects the batteries from over-discharge.

5.6 Well Pump Control Example (SOC Trigger)

The following example shows a well pump that is powered by a battery and uses the LYNK II relay to protect the battery from over-discharging.

Activated: 5 seconds after the battery SOC rises above 60%

Deactivated: 5 seconds after the battery SOC drops below 25%

Status: Relay 2 ●

Relay Status: ● Forced Off

Relay Profile: SOCTrigger

	Trigger	Trigger	Threshold	Delay
Activated	SOC	<	60 °C <input type="checkbox"/> °F	00 m : 05 s
Deactivated	SOC	>	25 °C <input type="checkbox"/> °F	00 m : 05 s

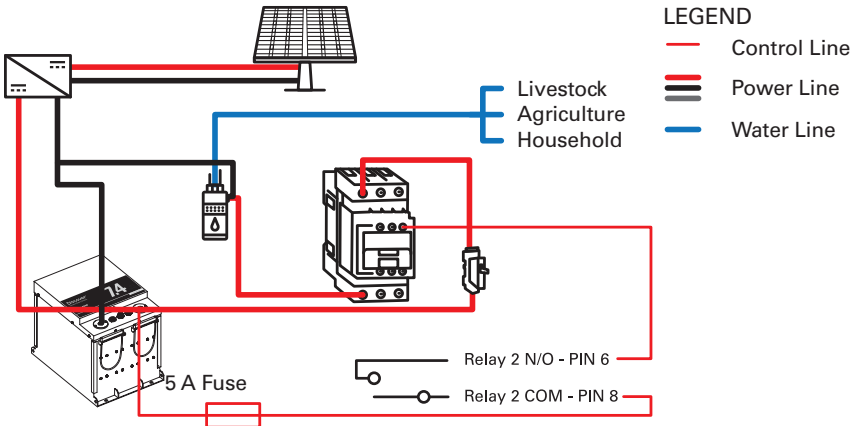

5 seconds after the battery SOC rises above 60%, the battery powers the well pump.
 5 seconds after the battery SOC drops below 25%, the battery stops powering the pump.

Solar panels recharge the battery.

5.7 Diversion of Excess Power Example (Cell Voltage Max Trigger)

A wind turbine is used to generate power and charge the battery. To prevent the battery from overcharging, a relay is set up to activate when the battery cell voltage is nearing its maximum level and uses power in the battery to heat water in an electric hot water tank.

Activated: 1 second after the battery cell voltage rises above 3550 mV

Deactivated: 1 second after the battery cell voltage drops below 3400 mV

Status: Relay 2 ● ● Forced Off

Relay Status: ● Forced Off

Relay Profile: Cell Voltage Max Trigger

Relay 2 N/O - PIN 6

Relay 2 COM - PIN 8

Trigger	Direction	Threshold	Delay
Activated Voltage Max	<	3550 mV	00 m : 01 s
Deactivated Voltage Max	>	3400 mV	05 m : 00 s

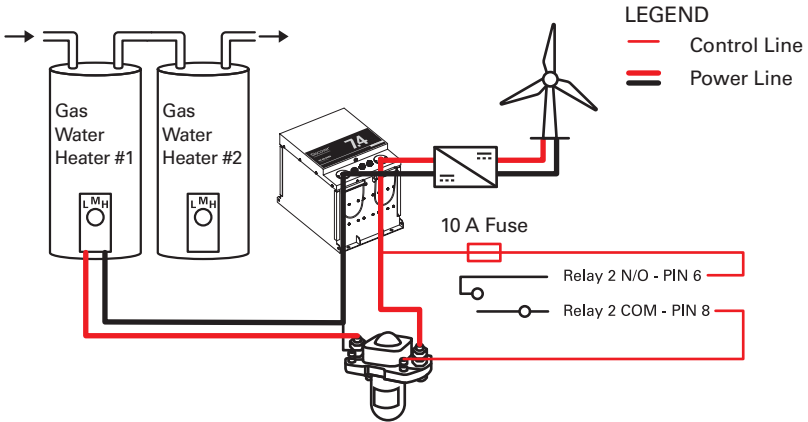

Once the switch (pin 6) is closed (activated), the battery powers the electric hot water tank until the battery cell voltage drops below 3.4 V for 5 minutes. In this system, the gas hot water tank is the main source of hot water, and the electric hot water tank is for preheating the water for use in the gas hot water tank.

Energy generated from the wind turbine either charges the battery or heats up the water. No energy is wasted in this system.